

Corvette Artwork

Your client is the main sponsor and event promoter of the annual Car Cruise and Music Festival at the Santa Monica Pier. You have been hired to create digital artwork for a number of elements that will be added to the event's Web site, including a game that he is going to develop with Flash programming functionality. The first step is to build a basic illustration that can later be used for the client's various purposes.

This project incorporates the following skills:

- Defining a movie file with appropriate settings for the job you're building
- Importing a scanned image provided by the creative director
- Using various drawing tools to develop a digital version of a rough sketch
- Understanding the different drawing modes that are available
- Changing fill and stroke colors using a variety of methods
- Adding depth using various shading techniques



Project Meeting

client comments

I'm planning a number of different projects to promote this year's event. The American sportscar area is always a big draw at the event, so I'd like to feature Corvettes on all of the event collateral.

Most of the print work is going to use photos, but I'm planning some other projects where I want to use artwork instead of a picture — animations, Web banners, and I'm even thinking about an interactive game.

I'm a Flash programmer, but not an artist. If you can create the artwork directly in Flash, that would save me some time when I implement my other plans.

One final thing — I don't want it to look like a cartoon. Obviously, I don't want it to be a photo, but I do want it to be realistic looking.

art director comments

I sketched out a Corvette, and scanned the sketch for you. I want you to use that sketch as the basis for your finished piece. Start by tracing that drawing using a bright color that you can see against the gray lines in the sketch.

Once you've finished the basic artwork, try to make it seem more realistic than just a flat color conveys. Add some dimension and depth so it doesn't look too much like a cartoon.

Also, make sure you build the artwork using logical layers. That way, if we need to make changes later, or if the client decides to animate it, the document will be structured properly.

Since Flash produces vector artwork, we can use the artwork for just about anything once it's done. The important thing for now, however, is to create a static file that we can post on our Web site for the client's approval.

project objectives

To complete this project, you will:

- Set up the workspace to match the requirements of the project
- Import the scan of the sketched Corvette
- Create a set of logical layers to hold the various components that you will create
- Understand the difference between object-drawing and merge-drawing modes
- Use the basic shape and line tools to develop the components of the drawing
- Draw precise Bézier curves with the Pen tool
- Use the Pencil tool to draw freehand shapes
- Apply color with the Paint Bucket, Ink Bottle, and Brush tools
- Use object groups to combine and protect drawing objects
- Apply and edit color gradients
- Export a static image for online review



Stage 1 Setting up the Workspace

CREATE A NEW DOCUMENT

1. Download **FL6_RF_Project1.zip** from the Student Files Web page.
2. Expand the ZIP archive in your WIP folder (Macintosh) or copy the archive contents into your WIP folder (Windows).

This results in a folder named **Car**, which contains all of the files you need for this project. You should also use this folder to save the files you create in this project.

If necessary, refer to Page 1 of the Interface chapter for specific information on expanding or accessing the required resource files.

3. In Flash, choose **File>New**.

When you create a new file, you can define a number of options for the file.

In the left side of the General tab, you can choose to create a new file for a specific output goal.

- The first two options allow you to target a specific version of ActionScript, the code language that is used to create interactivity (ActionScript 3.0 is the current version).

You will begin working with ActionScript in Project 4: Gator Race Game.

- The AIR, AIR for Android, and AIR for iOS options create files that can be distributed as standalone “apps” for (respectively) desktop use, Android tablets/phones, and Apple iPads/iPhones.

The **Width** and **Height** options define the Stage size, or the area that will be included in the final exported movie. In this project, you are using the Flash Stage as a drawing board (literally). You will adjust the Stage size in the next exercise to meet the needs of the drawing you will create.

The **Ruler Units** menu defaults to Pixels, which is appropriate for files that will be distributed digitally.

The **Frame Rate** defines the number of frames that exist in a second (frames per second, or fps). You will learn more about frame rate beginning in Project 2: Talking Kiosk Interface, when you start creating animations.

The **Background Color** option defines the color of the Stage; this color appears behind all elements that you create or place in the file.

The **Auto-Save** option can be activated to automatically save a working file at specific intervals. Keep in mind that if you activate this option, you will not be able to use the **File>Revert to Saved** command to go back to a version older than the set Auto-Save interval.

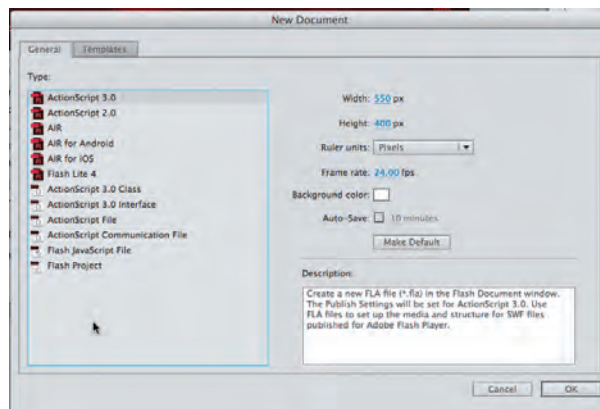

Note:

You can click the *Templates* tab to access pre-defined templates in many different styles.

Note:

Although there are slight differences in appearance between the Macintosh and Windows dialog boxes, the options are the same.

Note:

Press **Command/Control-N** to open the *New Document* dialog box.

4. In the General tab, make sure the first option — ActionScript 3.0 — is selected in the list, leave all other options at the default settings, and then click OK.

When you create a new file, the Stage is automatically centered in the document window. The Stage is essentially the workspace, or the digital “page” area; anything outside the Stage area will not be visible in the exported movie (although it will increase the file size, which affects its download time).

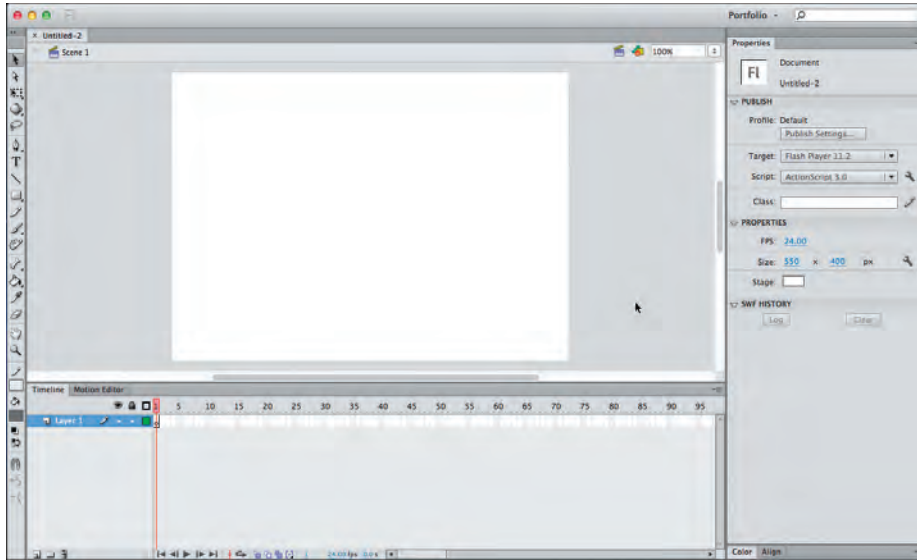

Note:

We have arranged our workspace to make the best possible use of space in our screen shots, including two docked and collapsed panels that we will expand when necessary. Feel free to arrange the panels however you prefer; for this project, you will be using the Tools, Properties, Align, Timeline, and Color panels.

5. Choose File>Save.

Because this is a new file that has not yet been saved, choosing the Save command automatically opens the Save dialog box, where you define the file name, save location, and format.

If a file has already been saved at some point, the Save command simply overwrites the previously saved version of the file. If you want to save the new version and maintain the original, you have to use the File>Save As command to define a new name and create a copy of the file.

Note:

Press Command/Control-S to save the active file.

Press Command/Control-Shift-S to use the Save As option.

6. In the resulting dialog box, navigate to your WIP>Car folder.
7. Change the file name to **corvette fla**. Make sure **Flash CS6 Document** is selected in the **Format/Save As Type** menu and click Save.

Native Flash files use the FLA extension. By default, the extension is included in the Save As/File Name field. You don't need to type it again if you don't delete the default extension from the field.

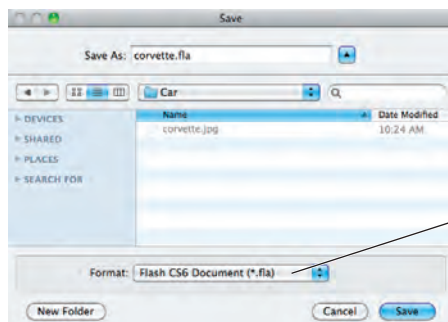

If necessary, you can use this menu to save a file to be compatible with the previous version of Flash.

8. Continue to the next exercise.



IMPORT A RASTER IMAGE

As we discussed during the production meeting for this assignment, you will base your work on a scanned sketch. Flash can import a range of file formats, including JPG, GIF, PNG, TIF, EPS (Encapsulated PostScript), and native Illustrator and Photoshop files.

1. With **corvette.fla** open, choose **File>Import>Import to Stage**.

Four options are available when you choose the Import command:

- **Import to Stage** simply brings an external image onto the current Stage. Imported bitmap images are also added to the file Library panel; if you import a vector graphic that uses no symbols or embedded bitmaps, nothing is added to the Library.
- **Import to Library** automatically places graphics into the Flash Library panel.
- **Open External Library** is commonly used to incorporate graphics from one project into another project.
- **Import Video** allows you to bring digital video into a Flash file.

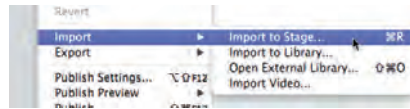

Note:

Press **Command/Control-R** to import an object to the Stage.

Raster Images vs. Vector Art

FLASH FOUNDATIONS

There are two kinds of computer images. The first, known as a **raster image** or **bitmap**, is composed of simple pixels. Each pixel has a specific value, and that value determines the color, intensity, and brightness of that pixel. The number of pixels that make up a raster image is fixed at the time of the scan or photograph. If you blow up (enlarge) a raster image, it becomes grainy and loses quality; in fact, you can see the individual pixels in an enlarged raster image.

Flash is a vector-based program. **Vector art** is not based on pixels; instead, it is based on mathematical values. Vector art is essentially a tiny program that tells the printer or monitor to "draw a line from Point A to Point B, bending X degrees coming out of Point A and entering Point B from an angle of Z." Although this might sound confusing, you don't have to write any complicated code to make vectors work properly; you can simply draw with the Flash tools and the vectors are created for you.

Although vector graphics often improve the quality of images in a movie, they can also degrade playback performance because they require greater processing power to perform the necessary mathematical calculations.

An example of the difference between a raster image and vector art is shown below. At 100% size, both the raster image and the type (composed of vector objects) are crisp. If you zoom in closely enough, however, the individual pixels in the photograph start to show, and the image breaks down — but the type remains perfectly crisp and clear.



At actual size, both the type in this image and the photograph appear perfectly crisp and clear.



The detail on the tree breaks down if you look closely enough.

The type object, which is a vector object, remains clear even when enlarged.

2. Navigate to your **WIP>Car** folder, select **corvette.jpg**, and click **Open/Import**.

The imported file is placed on the Stage, aligned to the left edge and centered vertically to the Stage area. As you can see, the placed image does not fit in the default Stage area.

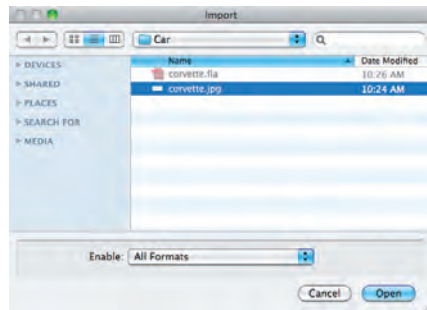

3. Note the placed image's width and height in the Properties panel.

Because the imported image is still selected, the Properties panel shows information about the image — most importantly for this exercise, the image's physical dimensions.

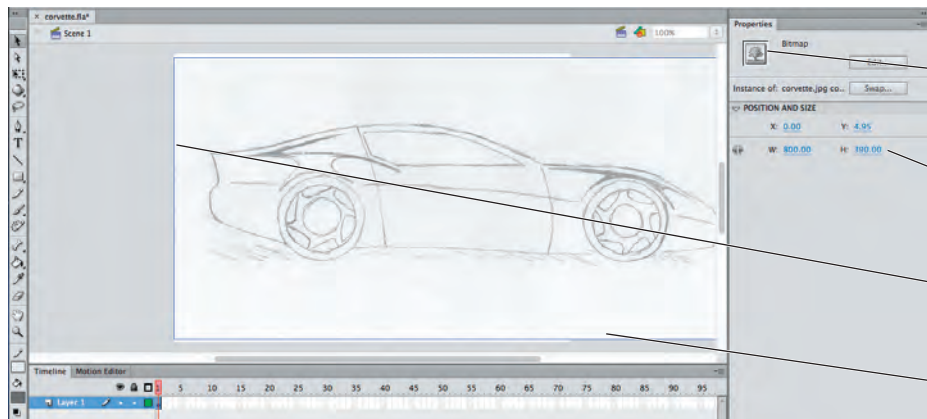

The Properties panel shows that the selected object is a bitmap file.

The object's position and size are clearly listed in the panel.

The placed file is aligned to the left edge and centered vertically on the Stage.

The placed file is wider than the current Stage area.

4. Save the file and continue to the next exercise.

CHANGE DOCUMENT PROPERTIES

The imported artwork is larger than the defined Stage size. Because you're going to trace the imported sketch, you need to make the Stage area large enough to hold the entire sketch (and ultimately, the finished artwork).

1. With **corvette fla** open, choose the **Selection tool** at the top of the **Tools panel**.
2. Click in the **gray area outside the Stage** to make sure **nothing is selected**.

When nothing is selected in the file, you can use the Properties panel to access a number of options that affect the entire document — including the file's physical dimensions.

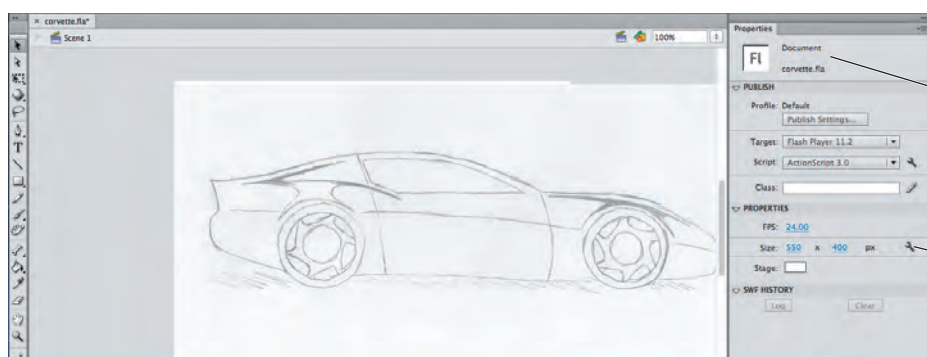

When nothing is selected, the Properties panel shows options related to the overall file.

Edit Document Properties button

3. In the Properties panel, place the cursor over the left number in the Size setting.

When the cursor is over an existing value, you can click and drag left or right to dynamically change the value (called a “scrubby slider”).



4. Click the existing value to highlight the existing field value, then type **850**.

Clicking an existing value in a panel accesses the actual field; you can type to change the value in the field.



5. Press Tab to highlight the Height field, then type **450 px**, to change the Stage height.

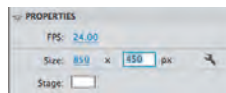

Note:

You can also simply click away from a field to finalize the new value.

6. Press Return/Enter to finalize the change.

7. If you can't see the entire Stage area, use the Hand tool to drag the Stage until you can see the entire Stage. If the entire Stage does not fit into your document window, choose Fit In Window in the View Percentage menu.

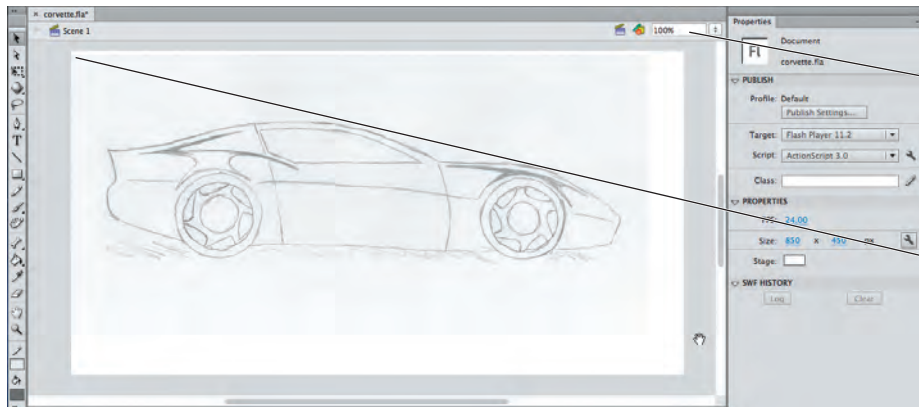

If necessary, use this menu to fit the entire Stage area in the document window.

The placed file's position relative to the Stage is not affected. The top-left corner is in the same spot as before you changed the Stage size.

Using the Document Settings Dialog Box

If you click the Edit Document Properties button in the Properties panel (or choose Modify>Document), you can access the same document properties that are available in the Properties panel when nothing is selected in the file.

The Dimensions, Frame Rate, and Background Color options are the same as those available in the Properties panel.

By default, changing the Stage size does not affect objects that are already placed on the Stage. You can check the **Scale Content with Stage** option to resize placed objects when the Stage size changes.

You can also use the **Match** options to automatically change the Stage size to match existing Contents (objects placed on the Stage) or Printer settings.

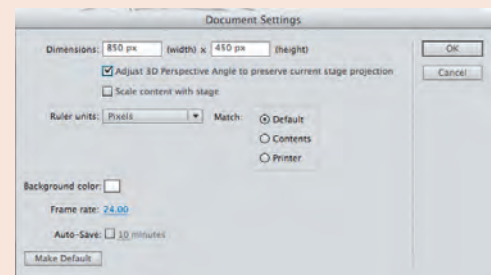

8. At the bottom of the Align panel (Window>Align), check the Align To Stage box.

When this option is active, you can use the Align panel to precisely position one or more objects relative to the defined Stage area in your file. (The Align panel remembers the last-used state of the Align To Stage option, so it might already be checked.)

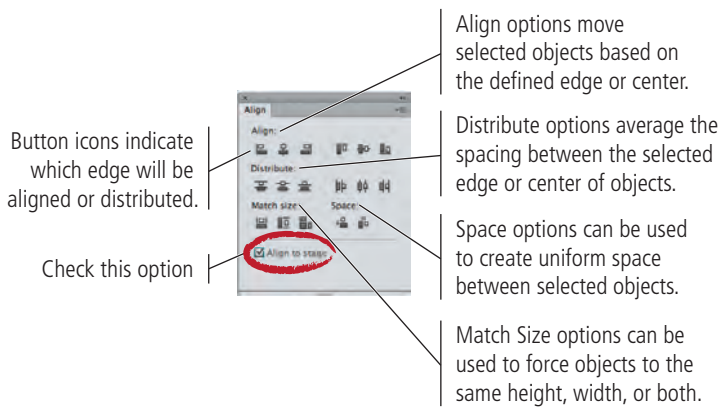

Note:

Press Command/Control-K to show or hide the Align panel.

Note:

Remember: all Flash panels can be accessed in the Window menu.

9. Click the sketch with the Selection tool to select it, and then click the Align Horizontal Center and Align Vertical Center buttons in the Align panel.

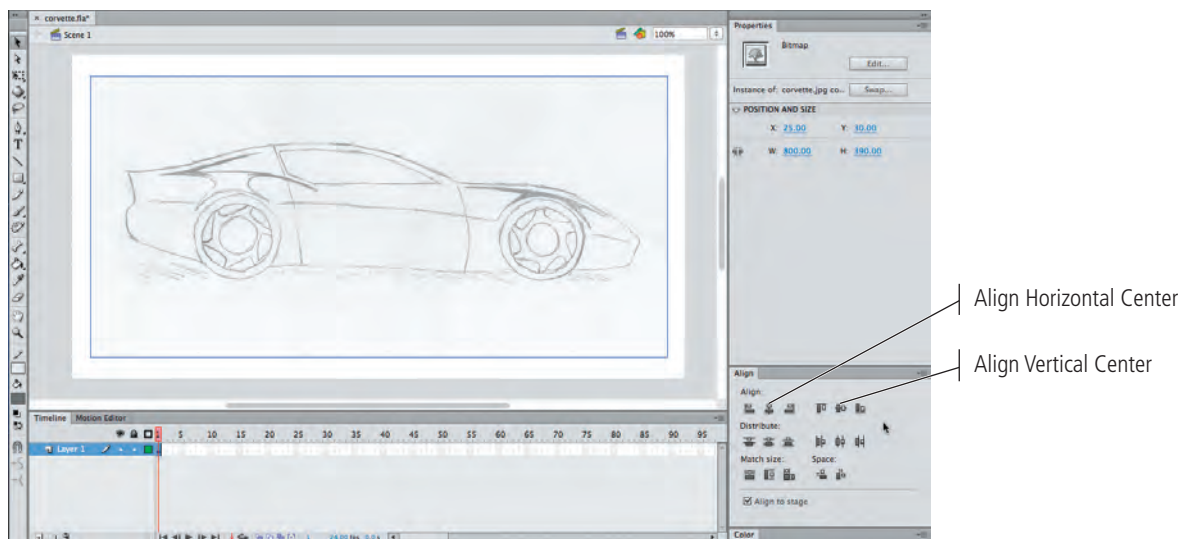

Align Horizontal Center

Align Vertical Center

10. In the Align panel, turn off the Align to Stage option.

If you later try to align multiple objects to one another and the Align to Stage option is still checked, the results will not be what you want. Although you can undo the Align process (Edit>Undo Align), it is a good idea to get into the habit of turning off the Align to Stage option as soon as you are finished using it.

11. Save the file and continue to the next exercise.

CREATE LAYERS FOR ORGANIZING ARTWORK

The Timeline panel allows you to easily create, arrange, and manage multiple layers in order to better organize your work. Layers can help you organize complex drawings and animations into a logical, easy-to-understand structure, while keeping all the components separate. You will use the timeline layers extensively as you complete the projects in this book.

1. With `corvette.fla` open, review the Timeline panel.

Layers are listed on the left side of the timeline; the order in which the layers are stacked (from top to bottom) is referred to as the layer **stacking order**. Objects on higher layers in the stack will obscure objects on layers that are lower in the stack. You can easily change the stacking order by dragging a layer to a new position in the stack.

Every file includes a default layer, named Layer 1. The icons to the right of the layer name provide a number of options, as well as some useful information.

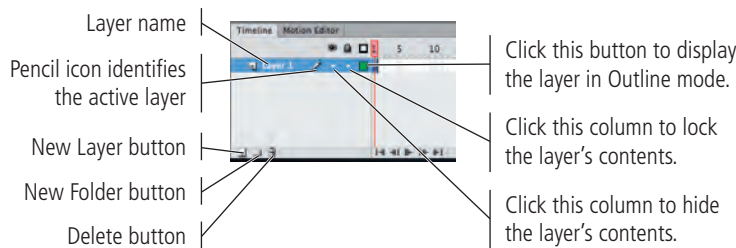

2. Double-click the name of the layer to highlight the name. Type **Sketch** to rename the layer, and then press Return/Enter to apply the change.

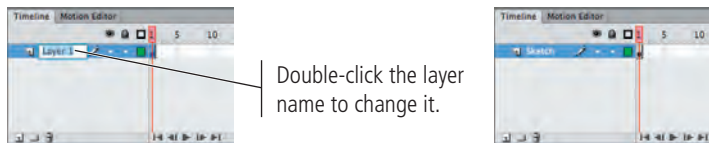

3. Below the list of layers, click the New Layer button to add another layer on top of the first layer.

The new layer is automatically added immediately above the previously selected layer. New layers (and layer folders) are created in the same nesting level as the currently selected layer. In this case there is only one level of layers (there are no layer folders), so all new layers will be placed at the primary level.

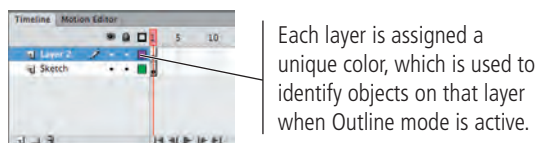

4. Using the same technique from Step 2, rename the new layer **Window** and press Return/Enter to apply the change.

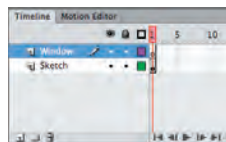

5. Repeat Steps 3–4 to create four more layers: **Body**, **Wheels**, **Door**, and **Accents**.

6. If you can't see all six layer names, click the bar above the docked Timeline panel and drag up to expand the panel.

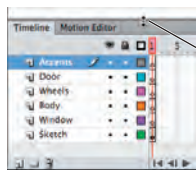

Drag this bar up or down to change the height of the Timeline panel.

7. If you can't see the full layer names, click the bar to the right of the Outline icons and drag right.

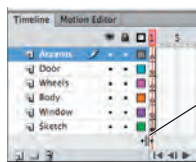

Drag this bar right to widen the area where layer names are listed.

8. Lock the Sketch layer by clicking the small dot below the Lock icon.

Locking the layer prevents you from accidentally deleting or otherwise modifying the sketch, which will be the basis for developing the actual drawing.

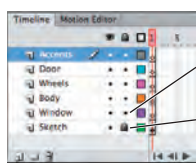

Click the dot to lock the layer.
Click the lock icon to unlock the layer.

9. Save the file and continue to the next stage of the project.

Note:

If your Timeline panel is not docked, click the bottom edge of the floating panel and drag down to expand the panel.

Note:

If a layer is selected but locked, the pencil is covered with a slash, indicating that you can't change objects on the layer or add objects to the layer.



Drawing Preferences

FLASH FOUNDATIONS

You can control a number of drawing options using the Drawing pane of the Preferences dialog box (accessed in the Flash menu on Macintosh, or in the Edit menu on Windows).

Each time you click with the Pen tool, you add an anchor point; successive anchor points are connected by lines. If the **Show Pen Preview** option is checked, a preview line follows the cursor to show the line that will be created when you add a new anchor point.

When the **Show Solid Points** check box is active, selecting an anchor point with the Subselection tool shows the selected point as solid instead of hollow.

You can change the Pen tool cursor () to a precise crosshair () by activating the **Show Precise Cursors** check box.

The **Connect Lines** options (Must Be Close, Normal, and Can Be Distant) determine how close lines or points must be before Flash automatically connects them.

The **Smooth Curves** options (Off, Rough, Normal, and Smooth) determine how many points will be used to create a line when you're drawing with the Pencil tool with the Smooth or Straighten options turned on. The Rough option results in more points and a jagged line; the Smooth option results in fewer points and a smoother line.

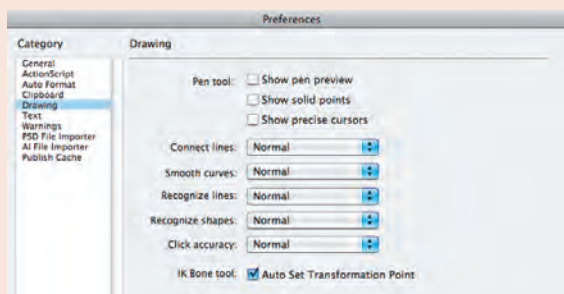

The **Recognize Lines** options (Off, Strict, Normal, and Tolerant) determine how close to straight a line drawn with the Pencil tool must be before Flash recognizes it as straight.

The **Recognize Shapes** options (Off, Strict, Normal, and Tolerant) determine how close to the shape an oval or square drawn with the Pencil tool must be before Flash recognizes it as the actual shape and makes the necessary adjustment.

The **Click Accuracy** options (Strict, Normal, and Tolerant) determine how close to an object you must place the cursor to select the object.

Stage 2 Drawing in Flash

Most drawing objects display two primary attributes: a fill and a stroke. The **fill** is the color contained within a shape, and the **stroke** is the line that defines the outside border of a shape. To change the fill and stroke of an object, use the pop-up Swatches panel that appears when you click the Stroke or Fill swatch at the bottom of the Tools panel.

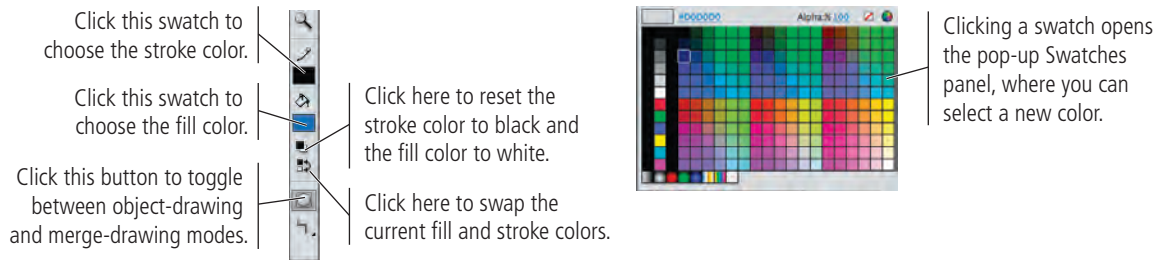

There are two modes for drawing in Flash: merge drawing and object drawing. When you draw with the basic shape tools, or with the Pen, Line, Pencil, or Brush tool, a toggle near the bottom of the Tools panel determines which type of drawing you will create.

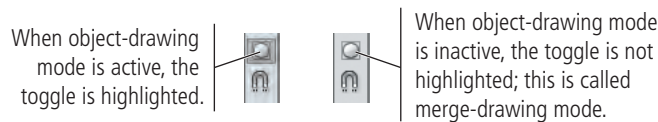

All shapes drawn in **merge-drawing mode** exist at the bottom of the stacking order on their layer. In other words, they are always behind other objects — groups, drawing objects, symbol instances, etc. — in the same layer. You cannot rearrange the stacking order of merge-drawing shapes.

When you create an object in merge-drawing mode, the fill and stroke are treated as separate entities. You can individually select each part with the Selection (solid arrow) tool, and you can move or modify each part without affecting the other.



You can select a part of a shape by dragging a marquee with the Selection tool.



When you drag one merge-drawing shape onto another on the same layer, the topmost shape removes whatever portion of the lower shape(s) it covers.

In the image to the right, the second column shows that we moved the orange circle on top of the blue circle. In the third column, you see the result of deselecting the orange circle, and then reselecting it and pulling it away from the blue circle. (This type of destructive interaction does not occur until you deselect the topmost object, which gives you a chance to “finalize” the edit. As long as you still see the crosshatch pattern on the object you’re dragging, the underlying objects have not yet been changed.)



This type of interaction does not occur with objects created in object-drawing mode or when you're working with grouped objects. If you select something with the Selection tool and see a bounding box instead of the crosshatch pattern, underlying objects will not be affected.

You can prevent this type of destructive editing by grouping the components of the shape. Simply drag a selection around the entire object and choose **Modify>Group**. When a standard object is grouped, you see only the group **bounding box** when you select the object on the Stage. (The bounding box marks the outermost boundaries of the shape.)

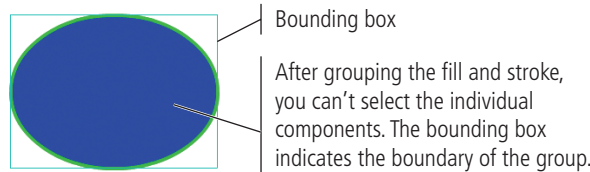

Note:

The color of an object's bounding box is defined based on the Highlight Color options in the General preferences.

Even when merge-drawing shapes are grouped, you can access the individual pixel components by double-clicking them on the Stage. This opens a secondary Stage — called **Edit mode** — where you can access and edit the individual components. The Edit bar above the Stage shows that you are no longer on the main Stage (Scene 1), but editing a group.

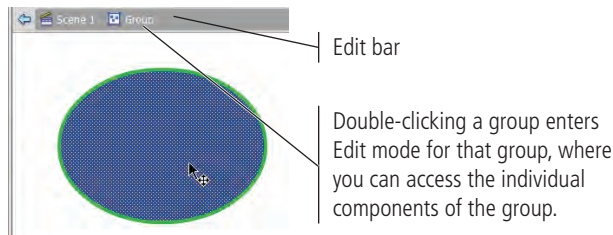

Of course, merge-drawing shapes have drawbacks as well; you could easily move or change an object that you don't want to change — such as dragging a fill away from its stroke and not realizing it until 15 steps later when it's too late to easily undo the error.

To solve this problem, you can draw in **object-drawing mode** by toggling on the switch at the bottom of the Tools panel. When you create a shape or line in object-drawing mode, it automatically displays the bounding box as soon as you create it, and you can't select the fill and stroke independently — at least not on the main Stage.

For a shape created in merge-drawing mode, you can use the Selection tool to independently select the shape's fill and stroke.

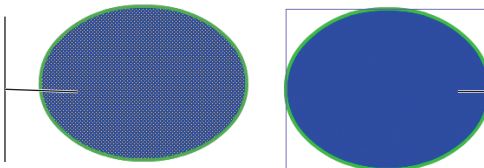

For a shape created in object-drawing mode, you can use the Selection tool to reveal the shape's bounding box. You can't independently select the object's fill or stroke.

If you want to access the individual components of an object created in object-drawing mode, simply double-click the object. Double-clicking activates Edit mode; the Edit bar shows that you are “inside” (editing) a drawing object.

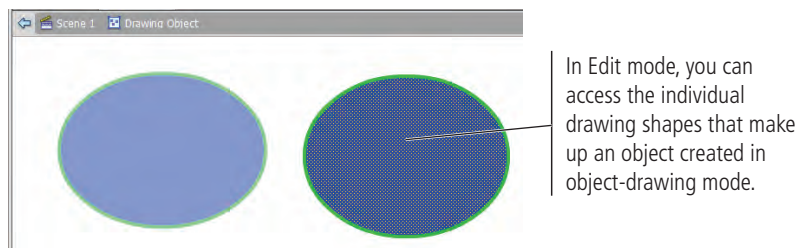

DRAW WITH THE LINE TOOL

The Line tool creates straight lines, which are simply strokes with no fills. You can combine lines with other shapes to develop custom objects. In this exercise, you draw several lines to complete the shape of the car's window.

1. With `corvette fla` open, click the Window layer (in the Timeline panel) to make it the active one.

Any objects you draw will be placed on the active layer. It's important to check which layer you're working on whenever you start to create new artwork. Many professionals prefer to lock all but the layer that is being used at a given time, although it isn't necessary if you remember to select the layer you want before you begin drawing.

2. Select the Line tool in the Tools panel. At the bottom of the Tools panel, make sure the object-drawing option is turned off.

The Object Drawing toggle is dark gray when active.  The Object Drawing toggle is not highlighted when inactive.

3. Using either the Properties panel or the Tools panel, click the Stroke Color swatch to open the pop-up Swatches panel.

When you select a drawing tool, the Properties panel provides a number of options that are relevant to the selected tool. These options remember the last-used settings, so some might already reflect the settings we define in the following steps.

The Stroke Color swatch in the Properties panel is the same as the Stroke Color swatch in the Tools panel. Changing either swatch reflects the same color in the other one.

When you use the Line tool, the Fill Color swatch in the Properties panel is always set to None. By definition, a line has no fill; you can't change the fill color of a line. The Fill Color swatch in the Tools panel, on the other hand, retains the last-used fill option. When you switch to a tool that creates filled shapes, the swatch in the Tools panel becomes the default fill color.

4. Choose a bright green color as the stroke color.

You can use any color you prefer; we are using green so it is easily visible against the gray lines in the sketch. Later in this project, you will change the stroke and fill colors of the various pieces to create the finished artwork.

Note:

You can Control/right-click a layer in the Timeline and choose Lock Others to lock all but the selected layer.

Note:

The Line tool does not create filled shapes, so the fill color is not relevant for this exercise.

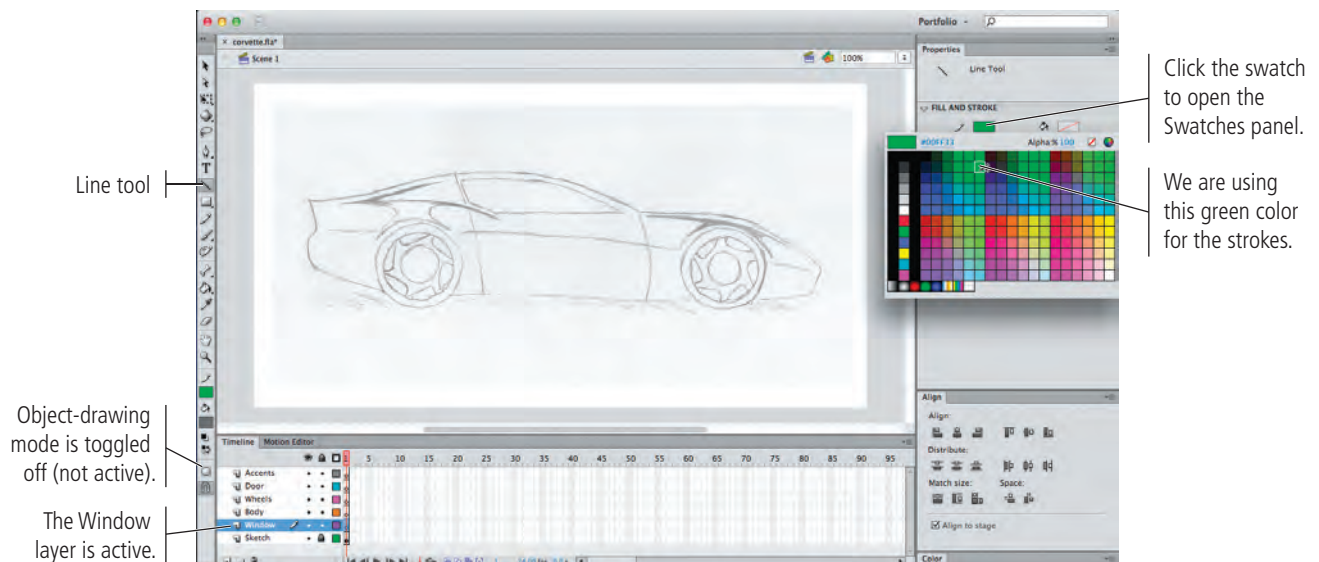

5. In the Properties panel, set the stroke height (thickness) to 2 and choose Solid in the Style menu.

You can type a specific stroke height in the Stroke Height field, or you can drag the associated slider for a live preview of the size you drag to (between 0.25 and 200 points).

Flash includes a number of built-in line styles, including dashed, dotted, ragged, stippled, and hatched. You can also edit the selected stroke style by clicking the pencil icon to the right of the Style menu.

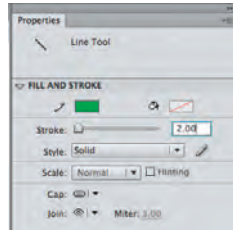

Note:

The Scale menu defines how strokes are affected by scaling a symbol in which the line exists. (This option only affects strokes that are part of a symbol, which you will learn about starting in Project 2: Talking Kiosk Interface.)

6. Open the Cap menu and make sure the Round option is active.

The Cap options define the appearance of a stroke beyond the endpoint of the line.



Note:

The Hinting check box helps when you draw straight lines that are connected to smooth curves. When this option is not checked, the curves might seem to be disconnected from the straight lines.

7. Open the Join menu and make sure the Round option is selected.

The Join options define the appearance of corners where two lines meet. When Miter is selected, you can define a miter limit in the Miter field. (This option is not relevant for Round or Bevel joins.) A miter limit controls when the corner switches from a pointed joint to a beveled joint, as a factor of the stroke height. If you define a miter limit of 2 for a 2-point line, the corner is beveled if the pointed corner extends beyond 4 points (2×2).

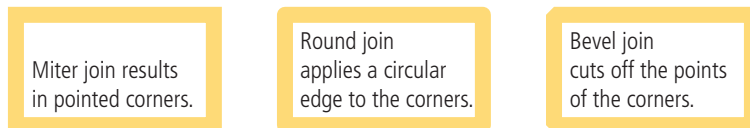

8. Zoom in to the window on the sketch.

As a general rule, we don't tell you the specific view percentage to use because every user's monitor and personal preferences determine a comfortable working environment. We do, however, tell you where to focus your attention.

9. Choose View>Snapping>Snap to Objects. If this option is already checked (toggled on), move the mouse cursor away from the menu and click to dismiss the menu.

As you draw different line segments with the Line tool, you want the ends of individual segments to align with each other. This is much easier when the Snap to Objects option is toggled on.

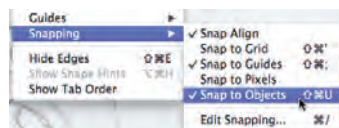

10. Click the top-left corner of the window, hold down the mouse button, drag down and right, to the bottom-left corner, and then release the mouse button. When you release the mouse button, do not move the mouse cursor.

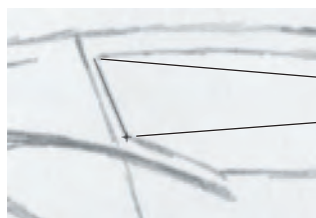

Click here...
...and drag to here.



When you release the mouse button, a line appears with the defined stroke properties.

11. With the cursor in the same position as when you finished the previous step, click and drag down and right to create the lower-left corner of the window shape (use the following image as a guide).

Because the Snap to Objects option is toggled on, when you first click you should see a small circle connecting to the end of the line you drew in the previous step. This indicates that the new line is connecting to that open endpoint.



A small circle indicates that you are connecting to the open endpoint of an existing line.



Click and drag to create the second line in the shape.

12. With the cursor in the exact position as at the end of Step 11, click and drag right to create the bottom edge of the window.
13. With the cursor in the exact position as at the end of Step 12, click and drag up and left until you see a small circle over the end of the first line you created, then release the mouse button.

Again, the circle icon indicates that you are connecting to the open endpoint of an existing line — in this case, you are closing the shape.

The circle indicates that you are connecting to the open endpoint, effectively closing the shape.



14. Save the file and continue to the next exercise.



ADJUST LINES WITH THE SELECTION TOOL

As the name suggests, the Selection tool is used to select objects. It can also be used to push or pull drawing objects into different shapes, almost as if you were pushing a string with your finger. In this exercise you will use this capability to bend the lines you just created into the correct shape for the car's window.

1. With **corvette fla** open, choose the Selection tool in the Tools panel.
2. Review the positions of the window corners. If any do not line up with the sketch, move the Selection tool cursor near the corner until a small corner shape appears in the tool icon. Click and drag to reposition the corner point.



The corner in the cursor icon indicates that you can click to drag the corner.

3. Move the cursor near the diagonal line that makes up the top of the window shape until you see a curved line in the cursor icon.

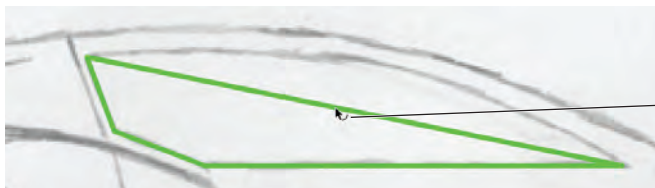

The curved line in the cursor icon indicates that you can click and drag to bend the line.

Note:

If an object is already selected, you have to first deselect it before you can use the Selection tool to bend the lines into different shapes.

4. Click and drag up to push the line into a curved shape that matches the sketch.

One unique aspect of drawing with Flash is using the Selection tool to pull or push a line into a different shape. When you release the mouse button, the line is reshaped.

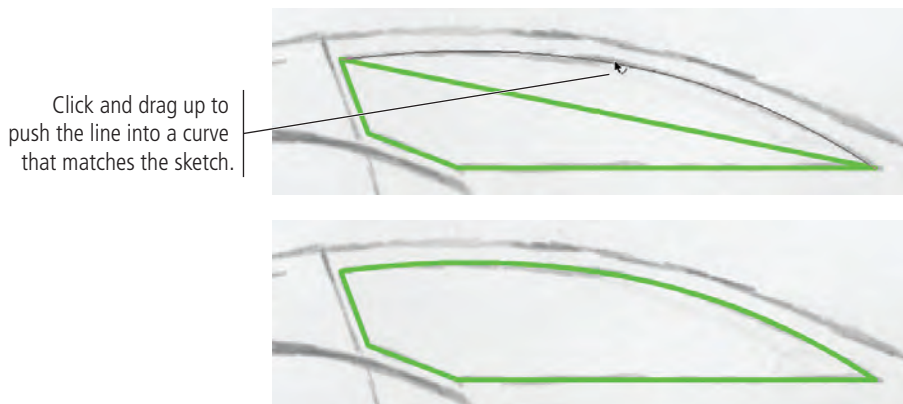

Click and drag up to push the line into a curve that matches the sketch.

Note:

This type of "bending" works for objects created in merge-drawing or object-drawing mode.

5. Repeat this process to slightly bend the diagonal line in the bottom-left corner of the window shape.



6. Save the file and continue to the next exercise.

Anchor Point Basics

Using the Subselection tool. When you click a line with the Subselection tool, you can see the object's anchor points. In the image to the right, both objects were selected by surrounding them with a selection rectangle; you can see all the objects' points and curves.



Paths selected with the Subselection tool show the anchor points.

Subselection tool cursor

Selecting entire objects or single points.

As you move the Subselection tool near a stroke, a small, solid black square appears at the bottom right of the icon. If you move the Subselection tool directly over a single anchor point, a hollow square in the icon indicates that clicking will select only that point.

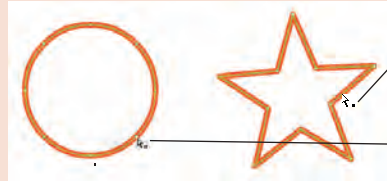

A solid square in the Subselection tool cursor indicates you are selecting the path.

A hollow square cursor indicates you are selecting the anchor point.

Moving points. To move an anchor point, select the point with the Subselection tool and move it to the desired location. You can also **nudge** (move just a little bit at a time) a point by selecting it and then pressing the Up/Down/Left/Right Arrow keys on your keyboard.

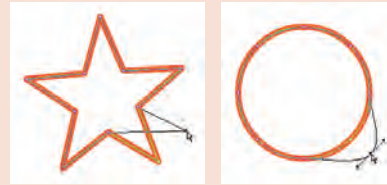

Reshaping a curve using its handles.

To reshape a curve, first select it with the Subselection tool, and then drag the related handles. (Handles will appear from each smooth anchor point that is connected to the curve.)



As you drag the handle up and out to the right, the shape of the curve changes accordingly.

Converting corner points to curves. To change a corner point into a smooth curve, first select the point you want to convert with the Subselection tool, then press the Option/Alt key and drag the point; handles appear, and the corner becomes a curve. You can then adjust the shape of the curve by adjusting the handles.



First, use the Subselection tool to select the point you want to convert, then Option/Alt-drag to pull out handles.

Converting curves to corner points.

If you need to convert a curve to a corner point, place the Pen tool over the curve point, press the Option/Alt key, and click to change the point to a sharp corner. (Alternatively, use the Convert Anchor Point tool.)

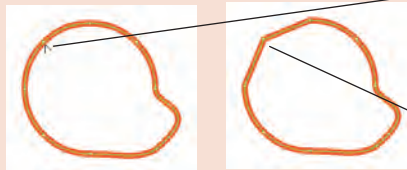

Press Option/Alt to access the Convert Anchor Point option.

Clicking changes a curve point to a corner point.

Adding anchor points. To add an anchor point, first select the path with the Subselection tool. Using the Pen tool, place the cursor near the path (but not over an existing anchor point) until you see a plus sign (+) in the tool cursor. Click the path to add a new point to the line. (Alternatively, use the Add Anchor Point tool.)

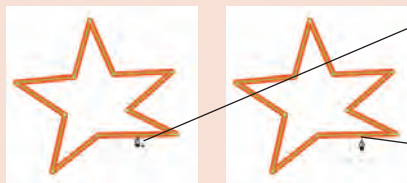

A plus sign (+) in the Pen tool cursor means clicking will add a point to the selected line.

Clicking adds a new point to the existing line.

Deleting anchor points. To delete an anchor point, first select the path with the Subselection tool. Using the Pen tool, place the cursor near an existing point until you see a minus sign (-) in the tool cursor. (Alternatively, use the Delete Anchor Point tool.)

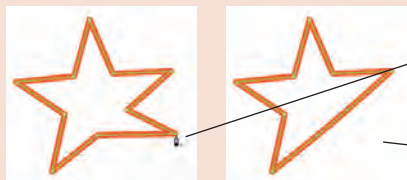

A minus sign (-) in the Pen tool cursor means clicking will remove a point from the selected line.

Clicking removes the point from the line.



DRAW WITH THE PEN TOOL

The Pen tool draws curved lines, known as **Bézier curves**, that are shaped based on the position of anchor points and their connected direction handles. This type of drawing creates very precise shapes, but can be difficult to master. In this exercise, you will draw the shape of the car body. While you work through the steps, you should try to get a feeling for how clicking and dragging affects the shape you create. The best way to master the Pen tool is to practice; as you gain more experience using the Pen tool, you will be better able to understand and predict exactly where you should click to create the shape you want.

1. **With `corvette fla` open, select the Body layer to make it the active layer. Zoom out so you can see the entire car shape.**

If the Body layer is locked, click the lock icon for the layer to unlock it.

Remember, to zoom out you can press Option/Alt and click with the Zoom tool, or press Command/Control-minus (-).

2. **Choose the Pen tool in the Tools panel, and toggle on the Object-Drawing mode option.**
3. **Click the Fill Color swatch in the Tools panel and choose the None swatch in the top-right corner of the pop-up Swatches panel.**

Because you want to be able to see the sketch through the shapes you create in this stage of the project, you are setting the fill to none.



Click the Fill Color swatch and choose the None option.

4. **Using the Properties panel, make sure you are using the same color and size stroke that you used to create the window shape.**

When you choose a new drawing tool, the object-drawing mode toggle, stroke, and fill properties retain the last-used options. If you took a break from this project after the previous exercise, make sure your drawing options are correct.

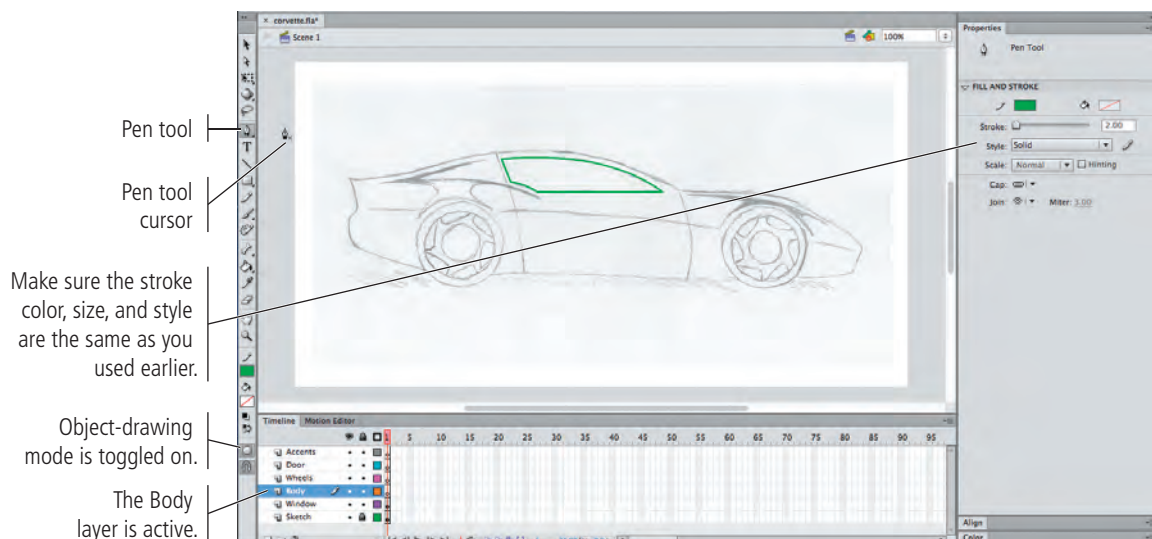

5. Click once at the top-left corner of the car shape.

Clicking with the Pen tool places an anchor point with no direction handles. (You might have to look very closely to see the anchor point.)



6. Move to the right until you are above the back edge of the rear wheel. Click and drag to the right to place an anchor point with symmetrical direction handles.

When you click and drag with the Pen tool, you create a smooth anchor point with symmetrical direction handles (the handles on both sides of the point are the same length, exactly opposite one another). The length and angle of the direction handles define the shape of the segment that connects the two anchor points.

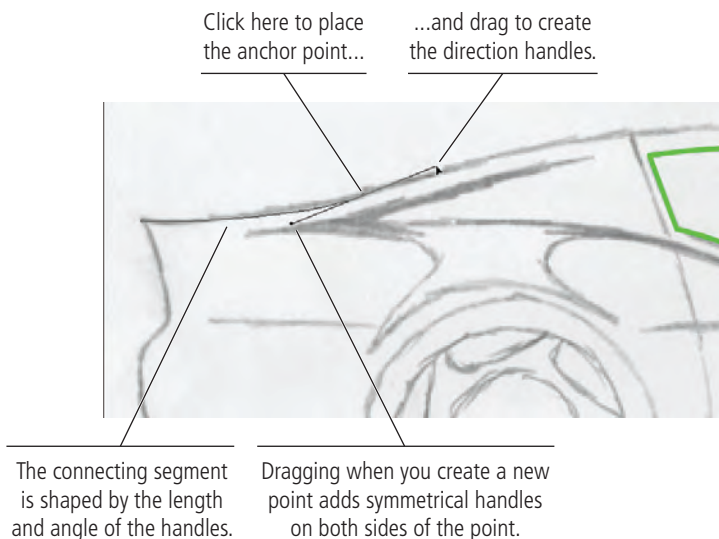

Note:

Pressing Command/Control while using the Pen tool temporarily switches to the Subselection tool. When you release the key, the Pen tool is again active.

7. Click and drag right again where the back of the door intersects the top of the car.

As you drag, notice how the position of the direction handles affects the shape of the connecting line segment. Experiment with dragging up, down, left, and right to see the effect on the curve shape.

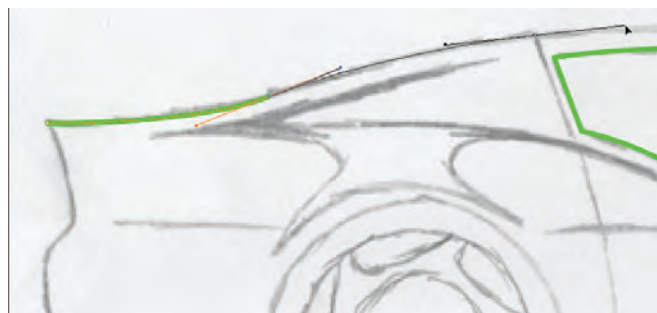

8. Click and drag again where the top of the car meets the hood.

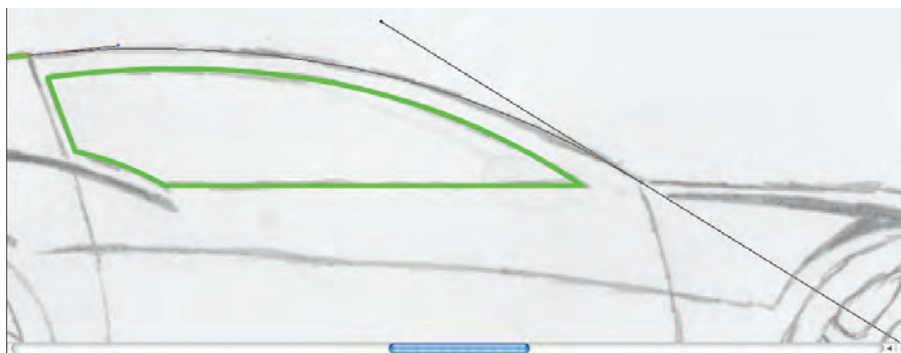

You can drag handles past the edge of the document window if necessary.

9. Place the cursor over the point you just created and click to remove the handle from the outside of the open point.

While you are drawing, clicking a symmetrical point again removes the direction handle from the outside of the point — converting the point to a corner point. The handle on the inside of the point remains because it is required to define the existing curve shape between the converted point and the previous one.

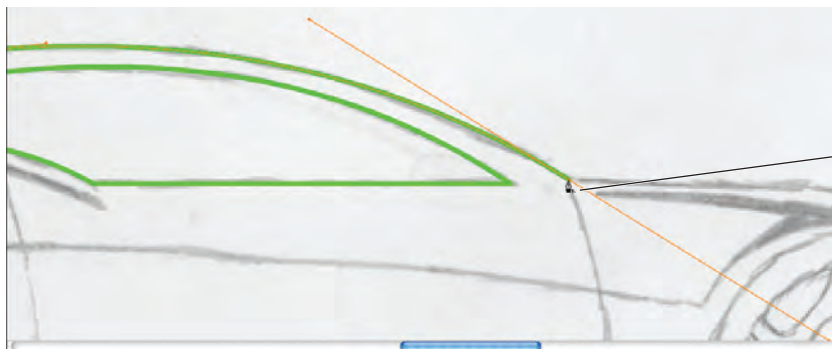

The upside-down v in the cursor icon indicates that clicking will convert this point to a corner point.

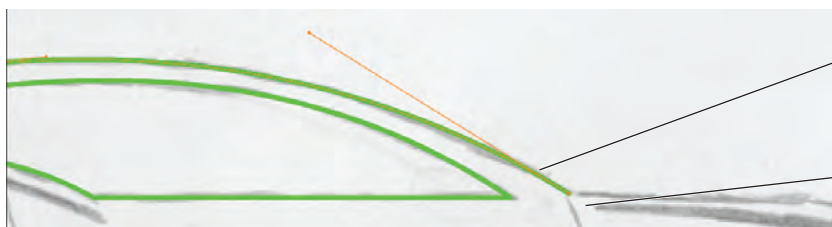

The inner handle is required to create the shape of the previous segment, so it is not removed from the new corner point.

Clicking removes the handle from the outside of the point.

10. Click and drag again near the corner of the front bumper.

Do not click the actual corner in the sketch. Because the bumper's edge is actually rounded, it's better to place anchor points on both sides of the curve rather than in the exact center of the curve.

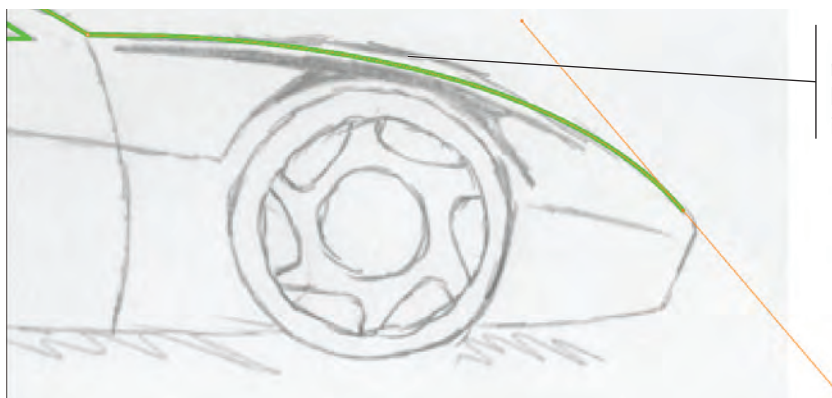

Don't worry about matching the sketched hood shape; you'll fix this in the next exercise.

11. Click on the front side of the bumper, just below the curve, and drag short handles along the path of the bumper's front edge.

As you can see in our example, symmetrical points often result in incorrect paths. You will learn how to fix this type of problem in the next exercise.



12. Click just before the bottom curve of the bumper shape and drag slightly along the path of the bumper's front edge.

The point here is to create a smooth point with handles on both sides, without significantly affecting the shape of the connecting curve. Dragging a very small distance accomplishes this goal.

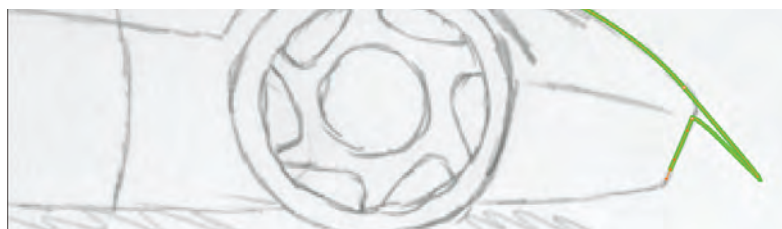

13. Click and drag slightly along on the bottom edge of the car, just past the bottom-front corner.



14. Continue drawing the rest of the car shape by clicking and dragging to place anchor points with handles. For the bottom edge, simply extend the bottom-edge line over the wheel shapes.
15. When you get to the end of the shape, place the cursor over the original starting point and click to close the shape.

When you hover the cursor over the original starting point, the cursor shows a hollow circle in the icon, indicating that you can click to close the shape.

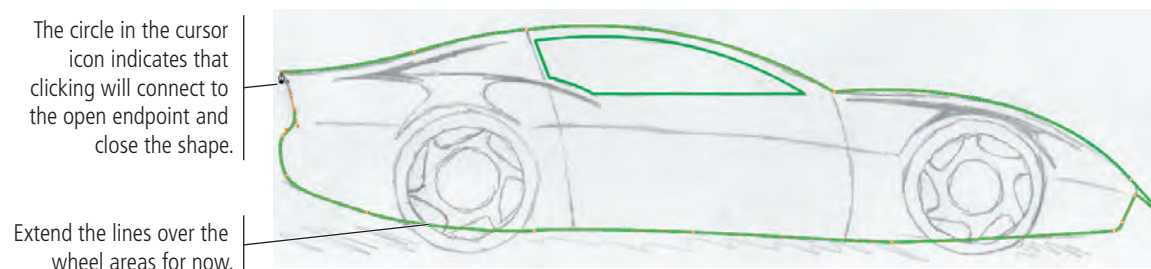

16. Save the file and continue to the next exercise.



ADJUST BÉZIER CURVE SHAPES

From the previous exercise, you might have guessed that many of the lines that you draw with the Pen tool will not be perfect when you first create them. Fortunately, the Subselection tool makes it easy to edit the position of individual anchor points, as well as the length and angle of the direction handles that define connecting line segments.

1. With **corvette.fla** open, zoom into the front end of the car.

2. Choose the Subselection tool in the Tools panel.

You can use the Subselection tool to access and adjust the anchor points that make up a line. You can also use this tool to adjust the direction handles that define the shapes of curves that connect two anchor points.

3. Click the green line on the hood to select the shape, then click the anchor point on the front edge of the car hood to select it.

Clicking a line with the Subselection tool reveals the shape's anchor points.

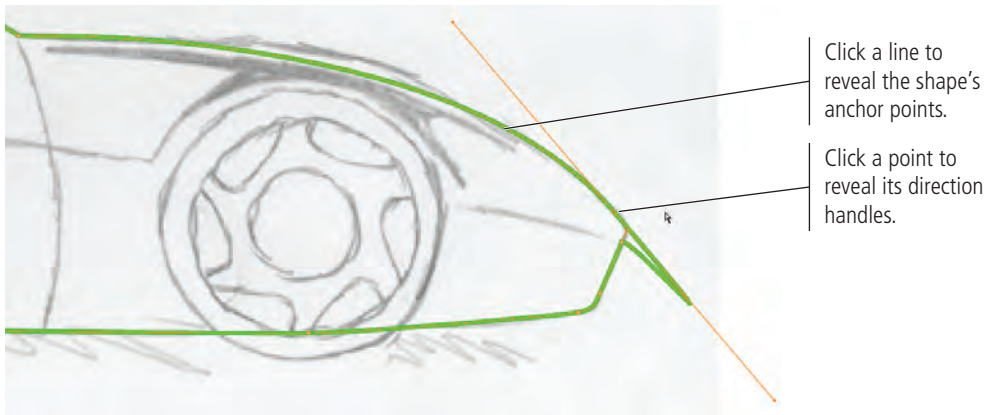

4. Click the outer direction handle (the one on the bottom) and drag up and left to reshape the curve on the top corner of the bumper.

When you drag one direction handle, the point remains smooth but it is no longer symmetrical; changing the length, but not the angle, of a direction handle affects only the segment on the same side of the point as the handle that you change.

Because this is still a smooth point, however, dragging one handle to a different angle would also affect the point's other handle — affecting the shapes of both segments that are connected to the anchor point.

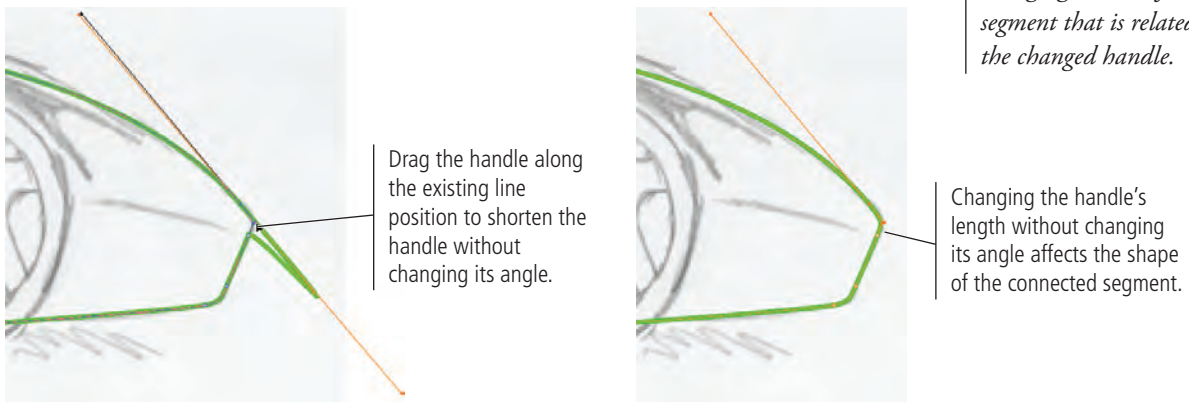

Note:

The Selection tool selects entire paths, but the Subselection tool selects individual anchor points. You use the Subselection tool to select and edit anchor points, or adjust curves using the handles that radiate from anchor points.

Note:

If you drag toward or away from the anchor point without changing the angle, you are changing the arc of the segment that is related to the changed handle.

5. Choose the Add Anchor Point tool (nested under the Pen tool), then click the existing line midway along the hood to add a new anchor point.

You can also add a point by moving the Pen tool cursor over an existing line segment.

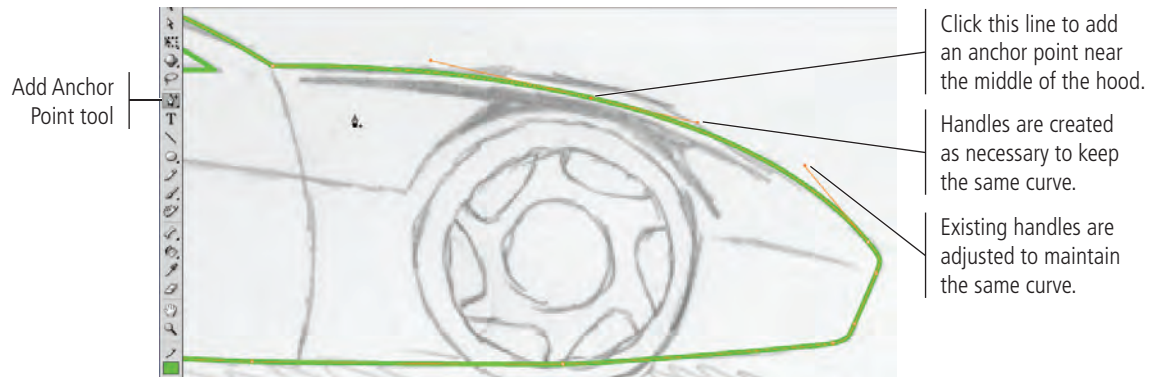

6. Using the Subselection tool, click the new point and drag until the path more closely resembles the line in the sketch.

When you move a point, the length and angle of the related handles are not affected. In many cases, you might need to move a point and then adjust the handles to achieve the effect you want.

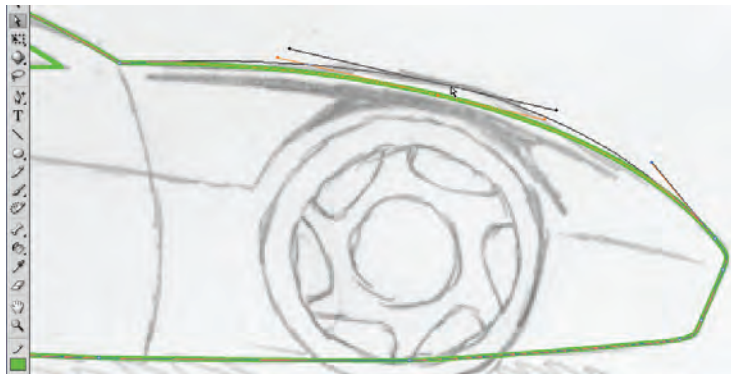

7. Review the position of each anchor point and line segment in the car shape. Make any necessary adjustments until you are satisfied with your drawing.

Keep the following points in mind as you fine-tune your shape:

- To move a point, click and drag with the Subselection tool.
- To add an anchor point, click an existing segment with the Pen tool (or use the Add Anchor Point tool that is nested under the Pen tool).
- To remove a point, click an existing point with the Pen tool (or use the Delete Anchor Point tool that is nested under the Pen tool).
- To convert a smooth point to a corner point, Option/Alt click the point with the Pen tool (or use the Convert Anchor Point tool).
- To convert a corner point to a smooth point, Option/Alt click the point with the Pen tool and drag to create symmetrical direction handles for the point (or use the Convert Anchor Point tool).

8. In the Timeline panel, click the dot under the Eye icon for the Sketch layer. Click the Stage (away from the existing shapes) to deselect everything, then review your progress.

Any time you are working from a sketch, it can be helpful to hide the sketch so you can better see exactly what you have created.

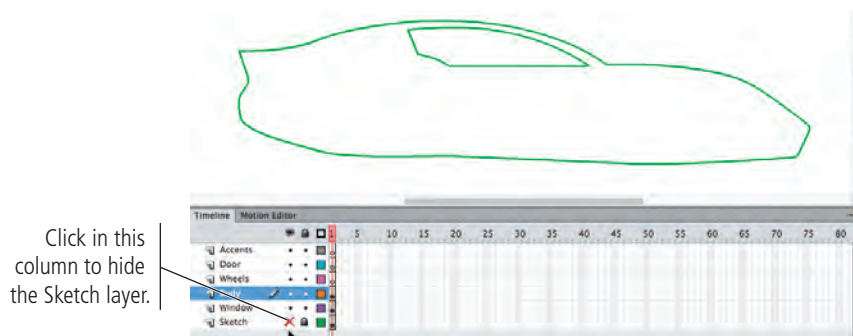

9. Click the red X for the Sketch layer to show that layer again.

Feel free to repeat this process throughout this project — we won't include this step again.

10. Save the file and continue to the next exercise.

USE DESTRUCTIVE EDITING TO CREATE SHAPES

When you work on a merge-drawing shape (in other words, one created without object-drawing mode toggled on), you can use the Selection tool to select specific pieces of objects:

- Clicking a stroke selects the line segment between the nearest two anchor points.
- Clicking a fill selects the entire area of the color you click.
- Double-clicking a merge-drawing shape selects the entire stroke and fill.
- Double-clicking the stroke of a merge-drawing shape selects the entire stroke.
- Clicking and dragging a marquee selects only the pixels inside the marquee area.

This behavior enables a type of **destructive editing** that is unique to Flash drawing tools. You can select and move or delete certain pieces of an object without affecting other pieces of the same object.

1. With **corvette fla** open, click the **Body** layer icon in the Timeline panel to select the layer.

When you select a layer, all objects on the layer become selected. In this case, the layer only contains one object — the shape of the car's body. You created this shape in object-drawing mode, so a bounding box identifies the selected object.

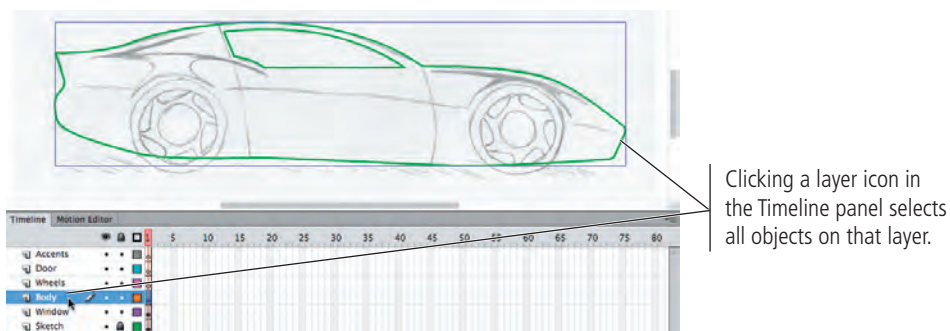

2. Using the Selection tool, double-click any line of the car body shape to enter into the drawing object.

Double-clicking an object on the Stage switches into Edit mode for the object (often referred to as “entering” the object). While in Edit mode for a particular object, you can see but not access other objects on the Stage.

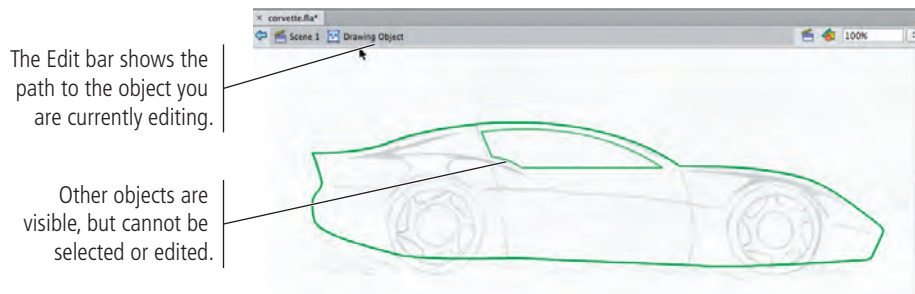

3. Choose the Line tool in the Tools panel. At the bottom of the Tools panel, make sure Object-Drawing mode is toggled on.

4. Draw a straight line where the back of the door is indicated in the sketch. Extend the line above and below the car body shape.

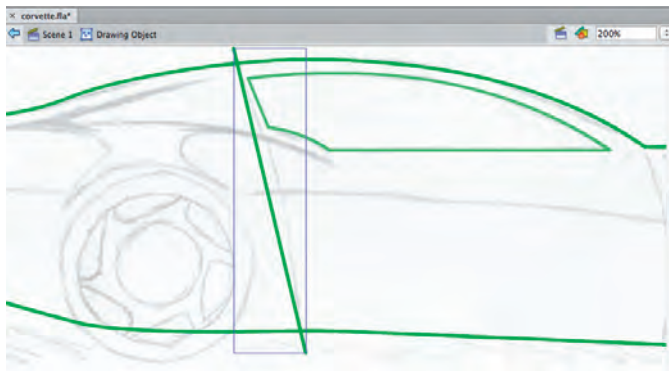

Note:

While drawing, press Command/Control to temporarily access the Selection tool; when you release the modifier key, you return to the last-selected tool.

The easiest way to deselect everything is to press Command/Control, and then click away from any object on the Stage.

5. Choose the Selection tool. Click away from the line to deselect it, and then use the Selection tool to bend the line into shape.

6. Click the line to select it again, and then choose Modify>Break Apart.

This command converts objects in object-drawing mode to merge-drawing mode so you can use the destructive editing capabilities of the Selection tool.

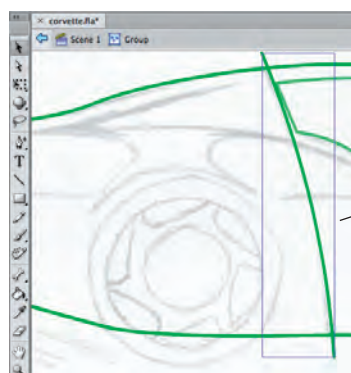

Before breaking apart, selecting the line with the Selection tool reveals the object's bounding box.

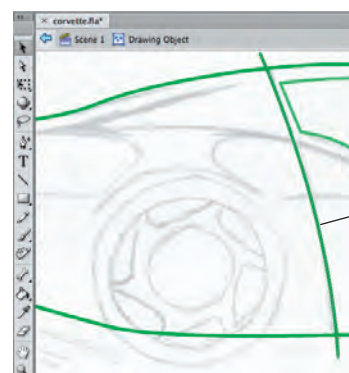

After breaking apart, the line is a merge-drawing shape; you can select the object's pixels with the Selection tool.

7. Choose the Subselection tool in the Tools panel, and click any of the lines that make up the car body shape.

All lines you create in Flash are vectors, which means their position and shape are defined mathematically based on the anchor points that make up the shape. Flash automatically creates whatever anchor points are necessary to reproduce the line you draw — including points wherever two lines overlap, as you can see where the vertical curved line intersects the car body shape.

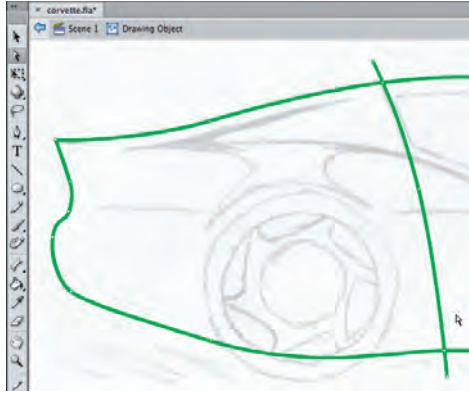

8. Click away from the lines to deselect everything, then use the Selection tool to click the overhanging line above the car.

The selected area displays a small cross-hatch pattern.

9. Press Shift and click the overhanging line below the car.

Pressing Shift allows you to select multiple objects at once; each item you Shift-click is added to the previous selection.

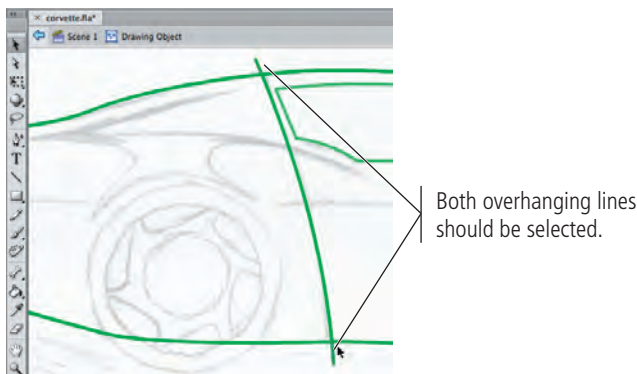

10. Press Delete/Backspace to remove both elements from the drawing.

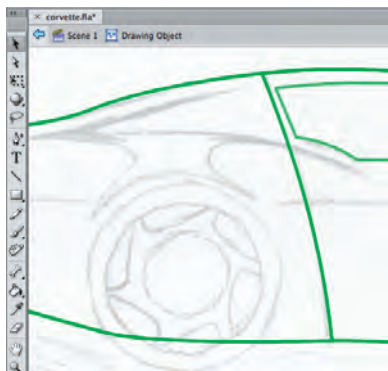

11. Repeat Steps 3–10 to create the line that marks the front of the door.

Later in this project, you need to be able to work with the car body shape as a single piece. If you left the door lines on the Body layer, the car shape would be effectively split into three pieces by the door-edge lines. To solve this potential problem, you are now going to move the door lines onto their own layer so they do not cut the car shape into pieces.

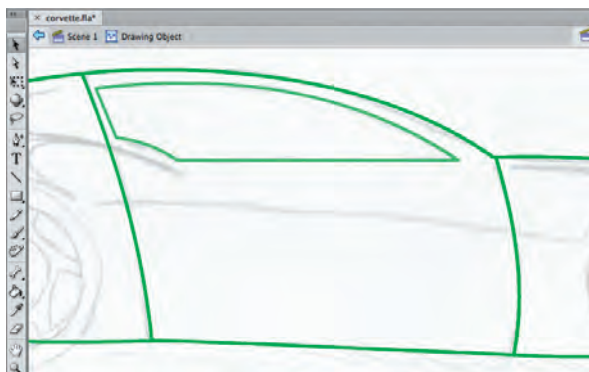

12. Using the Selection tool, click one of the door edges to select it, then Shift-click to select the other.

13. With both lines selected, choose Edit>Cut.

When you cut an object, it is removed from its original position and temporarily stored on the Clipboard — a reserved area of memory that allows you to temporarily hold objects until you need to use them again somewhere else. This is not the same as deleting (as you did in Step 10); when you delete a selection, it is not stored on the Clipboard.

14. In the Edit bar, click Scene 1 to return to the main Stage.

15. Select the Door layer as the target layer and then choose Edit>Paste in Place.

The Paste in Place command puts the cut objects in the exact position as they were cut from, but on the now-selected Door layer instead of the original Body layer.

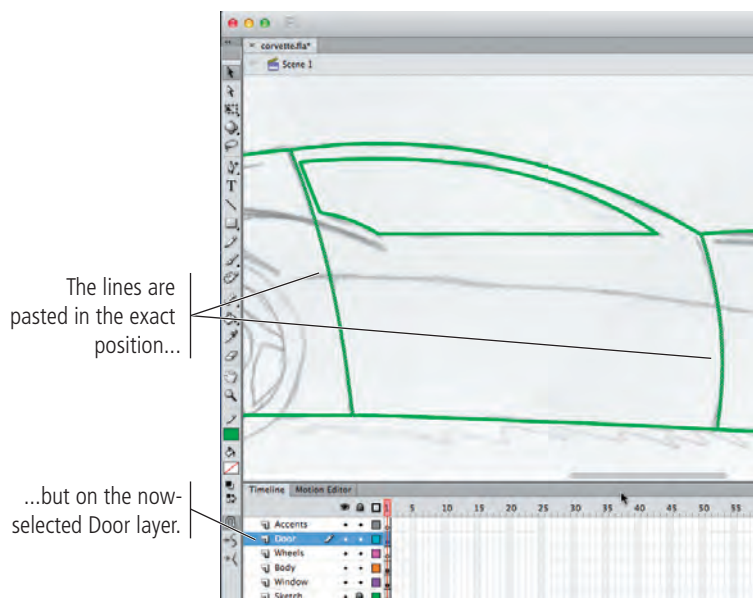

16. Save the file and continue to the next exercise.



DRAW WITH THE OVAL TOOL

Many otherwise complex objects are, in fact, simply a collection of primitive shapes. In the case of this car, you should recognize that the car's wheels are actually made up of three concentric circles. The basic shape tools — including the Oval tool — make it very easy to create this type of object.

1. With **corvette fla** open, select the **Wheels** layer (in the **Timeline** panel) as the active layer. **Zoom** into the rear wheel in the sketch.
2. Choose **View>Rulers** to show the Stage rulers at the top and left edges of the document window.
3. Click the horizontal ruler, hold down the mouse button, and drag down to place a horizontal guide in the center of the sketched wheel.

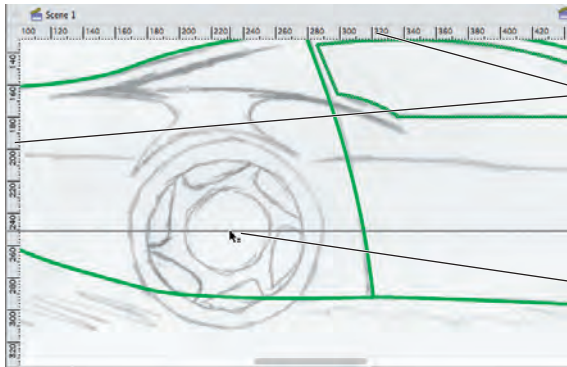

Rulers appear at the top and left edges of the document window.

Click the top ruler and drag down to place a horizontal guide.

Using Rulers, Guides, and Grids

FLASH FOUNDATIONS

Flash rulers, guides, and grids can dramatically improve accuracy and reduce development time. All three can be accessed and controlled in the View menu.

Rulers can be toggled on and off by choosing View>Rulers. Rulers normally measure in pixels, but you can use the General pane of the Preferences dialog box to change this setting to any measurement system you prefer.

The grid is a pattern of horizontal and vertical lines that also aid in the development/alignment process. The View>Grid submenu includes options for toggling the grid visibility (Show Grid), as well as editing the appearance and behavior of the grid (Edit Grid).

Guides are user-defined lines that you place on the Stage to mark a specific location; they are for development purposes only, and do not appear in the final output. The View>Guides submenu includes options for toggling guide visibility (Show Guides), preventing guides from being moved (Lock Guides), modifying the appearance and behavior of guides (Edit Guides), and removing all guides from the file (Clear Guides).

The View>Snapping submenu includes options for making guides (Snap to Guides) and the grid (Snap to Grid) act like magnets when objects are dragged near.

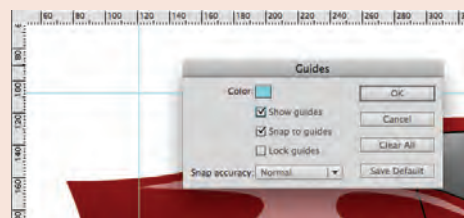
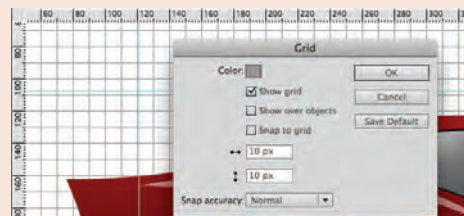

- Click the vertical ruler, hold down the mouse button, and drag right to place a vertical guide in the center of the wheel.

You will perform a number of steps in this and the next exercise that will depend on an exact center point — where these two guides intersect.

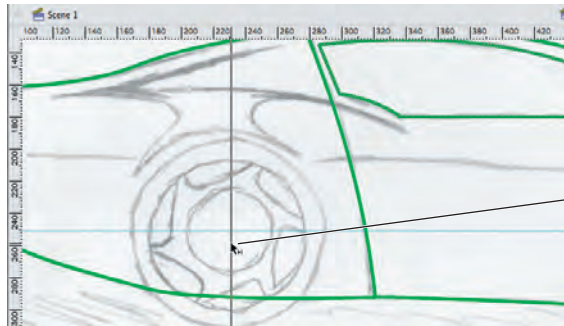

Click the left ruler and drag right to place a vertical guide.

Note:

Because this is a hand-drawn sketch, the wheels aren't exactly circular. It's okay if your circle doesn't exactly match the sketch.

- Choose the Oval tool (nested under the Rectangle tool) in the Tools panel. Make sure object-drawing mode is toggled on.
- In the Properties panel, make sure the fill and stroke settings match what you used in earlier exercises. In the Oval Options section, set all three sliders to 0.

The Oval tool shares many of the same properties as the Pen tool. You can define the fill and stroke color, as well as the stroke style, cap, and join.

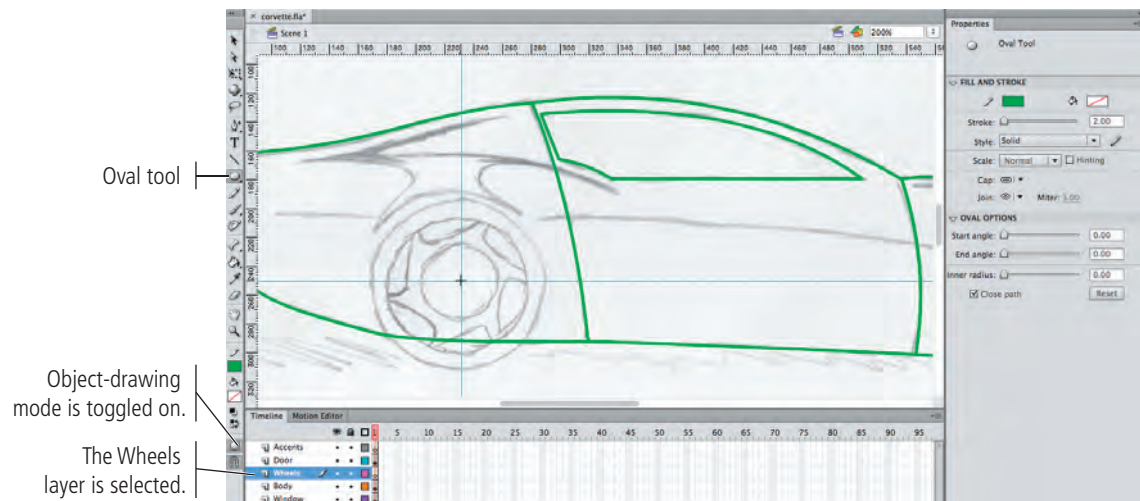

- Click at the intersection of the two guides, hold down the mouse button, press Option/Alt-Shift, and drag until the shape approximately matches the outer circle of the sketched wheel.

You can create a basic shape by simply clicking and dragging; the shape is anchored where you first click. Holding down the Option/Alt key as you drag draws the shape from the center out. Holding down the Shift key while dragging constrains the shape to equal height and width.

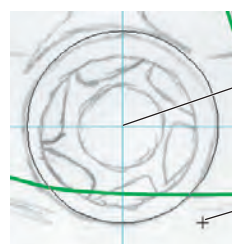

Click at the exact intersection of the guides, press Option/Alt-Shift...

...and drag to create a circle from the center out.

Note:

Whenever we say "click and drag", you should hold down the mouse button as you drag. We will not repeat the instruction to hold down the mouse button unless it differs in some way from the normal click-and-drag procedure.

8. With the new circle selected, choose Edit>Copy.

Copying stores the selected object in the Clipboard.

9. Choose Edit>Paste in Place.

Pasting places a copy of the Clipboard contents onto the selected layer. The Paste in Place command puts the copy in the exact position as the original. You can also choose Paste in Center to place the copy in the exact center of the document window.

10. Choose the Free Transform tool in the Tools panel.

When you select an object with the Free Transform tool, the object is bounded by eight transformation handles. You can use these handles to scale, stretch, skew, or rotate the selection. The hollow white circle in the center of the bounding box is the **transformation point**, which identifies the origin point around which the transformation will occur.

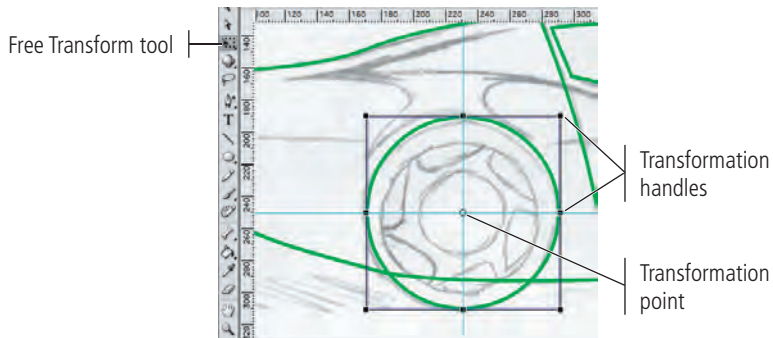

Note:

To copy an object, select the object and press Command/Control-C.

To cut an object, select the object and press Command/Control-X.

To paste an object from the Clipboard onto the Stage, press Command/Control-V.

To paste an object in place, press Command/Control-Shift-V.

Basic Shape Options

When you draw a basic shape, the Properties panel also includes options for defining the shape that will be created.

When you use the Oval tool, you can define the **Start Angle** and **End Angle** to create a shape with a defined wedge removed (such as you might see in a pie chart). You can also use the **Inner Radius** option to remove a circle from inside the circle; the defined value refers to the radius of the inner circle (the part that is removed). The **Close Path** option, which is checked by default, can be unchecked to create an open path rather than a closed shape.

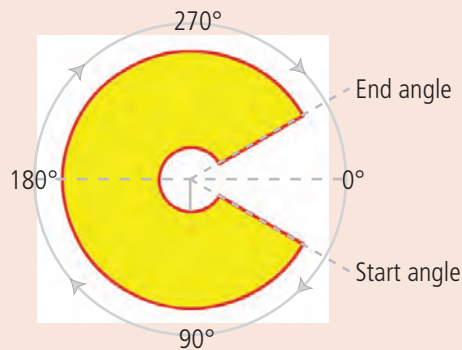
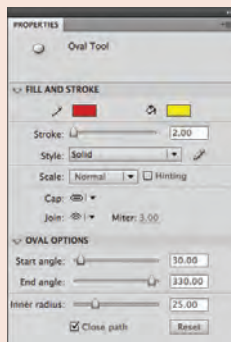



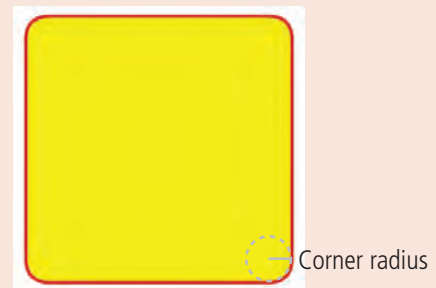
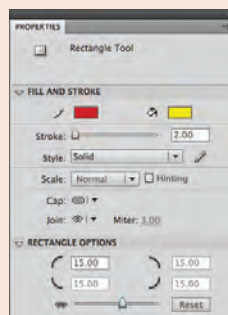

When you use the Rectangle tool, you can easily create a shape with rounded corners. The Options area in the Properties panel defines the **Corner Radius**; by default, all four corners are linked, but you can click the chain icon to define a different radius for each corner. (To understand the concept of corner radius, think of an imaginary circle at the corner of the shape; the radius of that circle is the corner radius, as shown in the following image.)

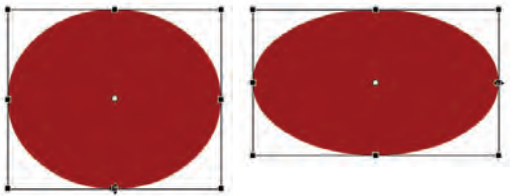
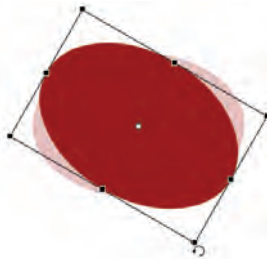
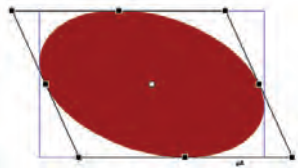

Using the Free Transform Tool

Free Transform mode allows you to change an object (or group) on the Stage by simply dragging. You can enter Free Transform mode by selecting an object with the Free Transform tool, by pressing Q (the keyboard shortcut for the tool), or by choosing **Modify>Transform>Free Transform**.

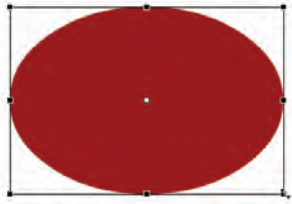
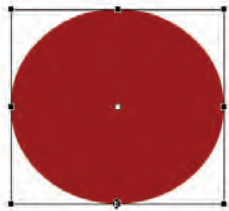
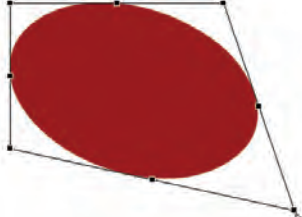
In Free Transform mode, the selected object is surrounded by a black bounding box with heavy black handles. A hollow circle in the center indicates the object's transformation point. Depending on where you place the cursor, you can apply different kinds of transformations. The cursor icon changes to reflect the change you will make by dragging.

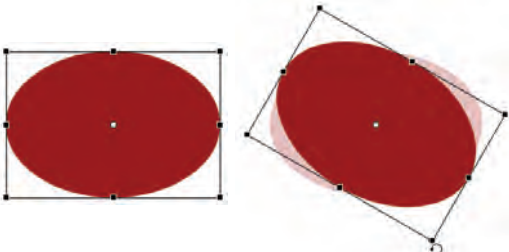
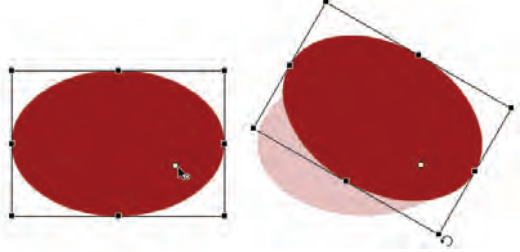
 <p>Click a side handle and drag to resize the object's height (left) or width (right).</p>	 <p>Click outside a corner handle and drag to rotate the object.</p>	 <p>Click and drag between handles on any side to skew the object.</p>
 <p>Click a corner handle and drag to resize both height and width at once.</p>	 <p>Press Shift while dragging a corner handle to maintain the original height-to-width ratio in the resized object (called "constraining").</p>	 <p>Press Option/Alt while dragging a handle to apply a change around the transformation point. (In this example, Option/Alt-dragging the bottom handle also moves the top handle.)</p>
 <p>Press Command/Control while dragging a corner handle to distort the object shape.</p>	 <p>Press Command/Control while dragging a side handle to skew and resize an object at the same time.</p>	
 <p>Transformations such as rotation and skewing apply around the transformation point, which defaults to the center of the object.</p>	 <p>Moving the transformation point (left) changes the fixed point around which the rotation applies (right).</p>	

11. Press Option/Alt-Shift, click the bottom-right bounding box handle, and drag up and left to shrink the circle around the center point.

Here pressing Option/Alt applies the transformation around the transformation point, which defaults to the center of the selected shape. Adding Shift constrains the transformation so the object's height-to-width ratio remains the same as the original.

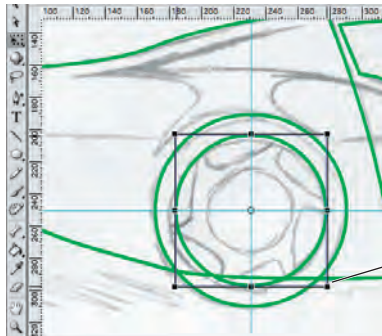

Option/Alt-Shift-drag the corner handle to resize the circle around the transformation point.

12. Repeat Steps 8–11 to create the third circle in the wheel shape.

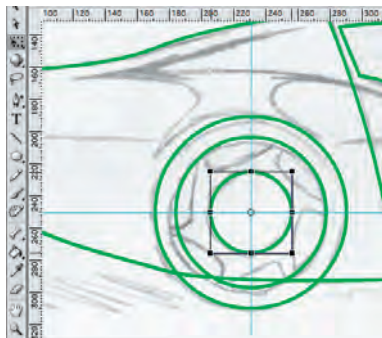

13. Save the file and continue to the next exercise.



DRAW WITH THE PENCIL TOOL

The Pencil tool provides another way to develop curved artwork. Drawing with the Pencil tool is easy; simply drag a line or shape, and the stroke — in whatever color is currently set in the Tools panel — follows the cursor.

With the proper equipment — notably a pressure-sensitive drawing tablet — the Pencil tool might very well be the most important tool Flash offers. This notion is particularly true for artists skilled at sketching or drawing with natural media such as pen and ink, pencils, and pastel chalks. Other people find the Pencil tool difficult to use, preferring the Pen tool, Bézier curves, primitive shapes, freeform shapes, and combinations thereof.

- 1. With `corvette fla` open, make sure the **Wheels** layer is active. Hide the **Body** layer so the lines do not interfere with the area where you are working.**

- Choose the Pencil tool in the Tools panel. At the bottom of the Tools panel, make sure Object Drawing is toggled on.

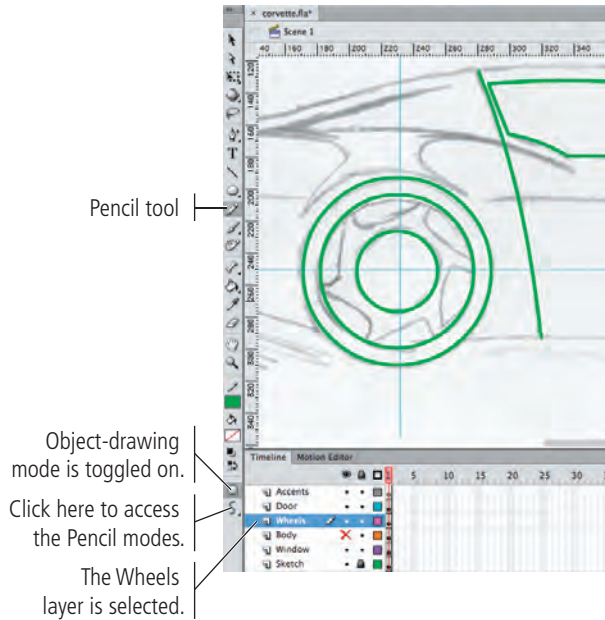

Note:

In the Properties panel, options for the Pencil tool are the same as those for the Pen tool.

- Click the mode button in the Tools panel and choose the Smooth option.

The Pencil tool offers three possible modes:

- Straighten mode favors straight lines and corner points.
- Smooth mode favors curves and smooth anchor points in the resulting paths. This option allows greater tolerance for slightly jerky movement as you drag, which can be very useful if you are using a mouse instead of a drawing tablet.
- Ink mode closely follows the path that you draw, placing a large number of anchor points to capture very small movements of the cursor; this mode often results in a very jagged path, especially if you are using a mouse instead of a drawing tablet.

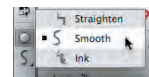

- Click and drag to create one of the inset shapes on the wheel. Make sure you overlap the line ends with the second circle, as shown in the following image.

When you release the mouse button, the Smooth mode should result in a fairly rounded inset shape.

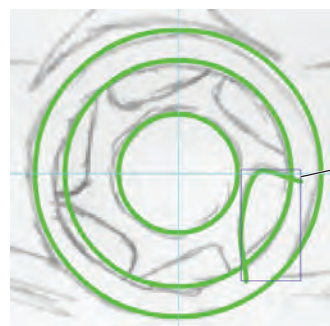
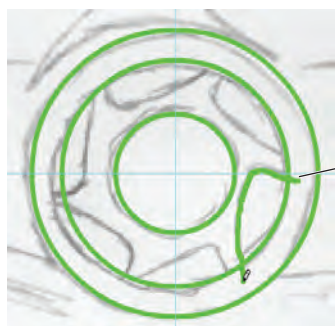

- With the new shape selected, click the Free Transform tool to reveal the transformation handles.

6. Click the transformation point and drag to the intersection of the two ruler guides.

You are going to copy and rotate this object around the wheel's center point to create the six inset shapes. The ruler guides that you placed mark the center of the wheel, which you used when you Option/Alt dragged from the guide intersection to create the circles. To rotate the inset shape around the same center, you are now moving the first shape's transformation point to the same center point as the overall wheel shape.

The Free Transform tool is selected.

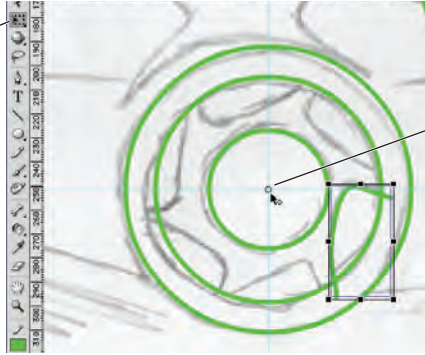

Drag the transformation point from the center of the shape to the intersection of the guides.

7. With the object selected, choose Edit>Copy.

8. Immediately choose Edit>Paste in Place.

Because you moved the transformation point before copying and pasting the object, the pasted copy also has the same relocated transformation point.

9. Move the cursor outside one of the object's corner handles until you see the rotation icon in the tool cursor.

10. Click and drag left to rotate the copy, approximating the position of the second inset.

As you drag, you should recognize that the object is rotating around the repositioned transformation point; in other words, it's rotating around the wheel center.

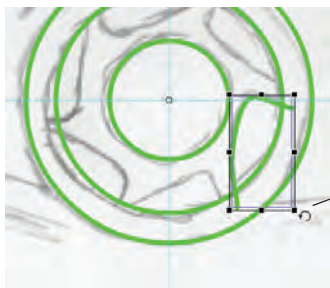

Place the cursor near a corner point until you see the rotation icon.

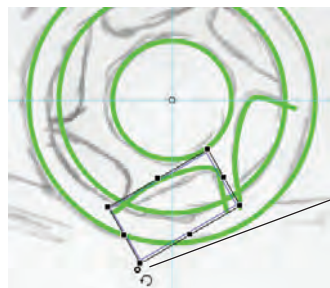

Click and drag to rotate the object around the defined transformation point.

11. Repeat Steps 7–10 four more times to create the six wheel insets.

In this case, don't worry about perfectly matching the sketch. The important point is to have six inset shapes, spaced approximately evenly around the wheel shape.

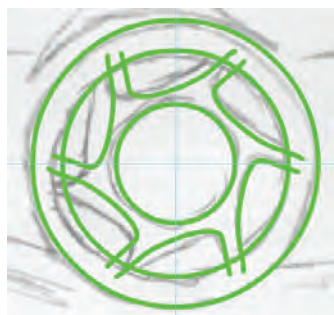

12. Choose View>Guides>Clear Guides.

You no longer need the wheel's center-point reference now that all of the necessary shapes are in place, so you can delete the ruler guides.

Note that this menu also includes options for showing or hiding guides, locking guides, and numerically editing the position of a guide. These options are all useful at some point, depending on the purpose of a particular guide.

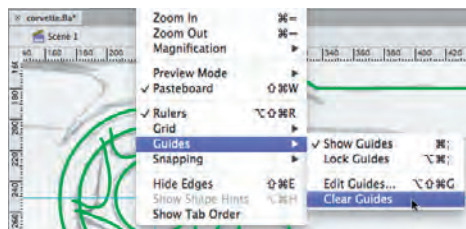

13. Save the file and continue to the next exercise.

WORK WITH AN OBJECT GROUP

You want to be able to access the individual shapes that make up the wheel, but you also want to be able to treat the wheel as a single unit on the main Stage. A **group** is a collection of shapes that is combined so it can be treated as a single object.

1. With *corvette.fla* open, hide the Sketch layer to make the wheel shapes more prominent.
2. Use the Selection tool to draw a marquee around all the shapes that make up the wheel artwork.

Because you created these objects in object-drawing mode, you can see a bounding box surrounding each shape. To prevent moving one of these components independently of the others, you can group them into a single unit.

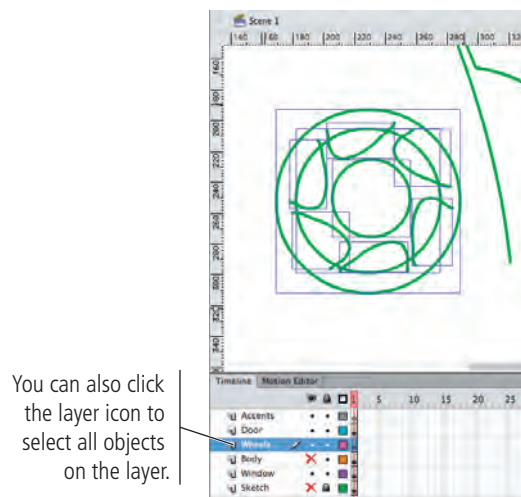

Note:

Press Command/Control-A to select all objects (on all layers) that are not locked.

3. Choose **Modify>Group**.

When you group objects, the bounding box displays around the entire group. By manipulating the bounding box, you can resize, move, and otherwise modify a group as you would a single object. Grouped objects are isolated from other elements on the same layer, so you can place grouped objects on top of one another with no worries of damaging the underlying objects.

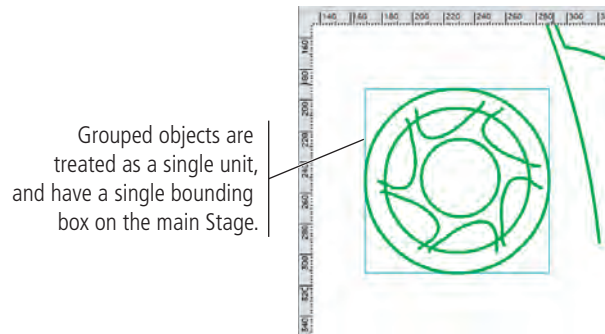

Note:

You can group objects by pressing Command/Control-G.

To ungroup objects, select the group and choose Modify>Ungroup or press Command/Control-Shift-G.

4. Double-click the group to enter into it (view the group in Edit mode).

Even though the objects are grouped on the main Stage, you can still access the individual components in Edit mode.

Because you drew these shapes in object-drawing mode, you can't access the pixels of the lines. You can't select and delete parts of the lines with the Selection tool, which you need to do.

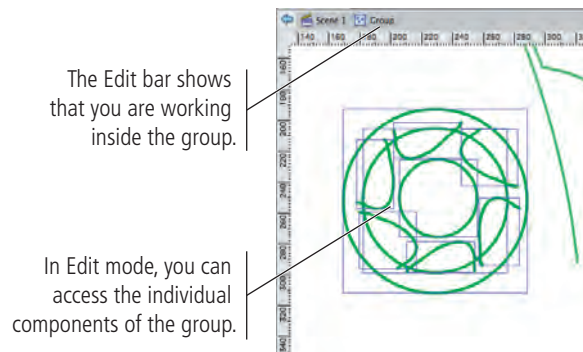

5. With all objects in the group selected, choose **Modify>Break Apart**.

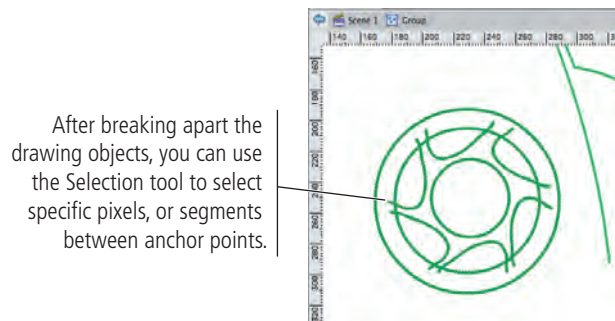

6. Click away from the lines to deselect everything.

7. Click to select one of the overhanging lines between the outer and middle circles, then press **Delete/Backspace**.

Remember from the earlier discussion on destructive editing that when you're editing a drawing object, Flash recognizes and separates overlapping elements.

8. Repeat Step 7 to remove all of the extraneous line segments.

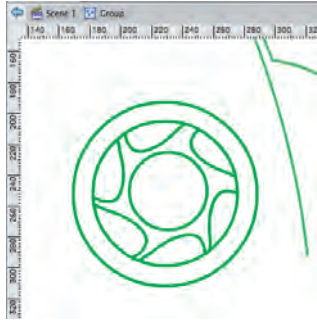

9. In the Edit bar, click Scene 1 to return to the main Stage.

Because these objects started as a group, and you made all the edits inside the group, the selection on the main Stage is still treated a single unit; the bounding box surrounds the outer edge of all the objects in the group.

10. Show the Body and Sketch layers.

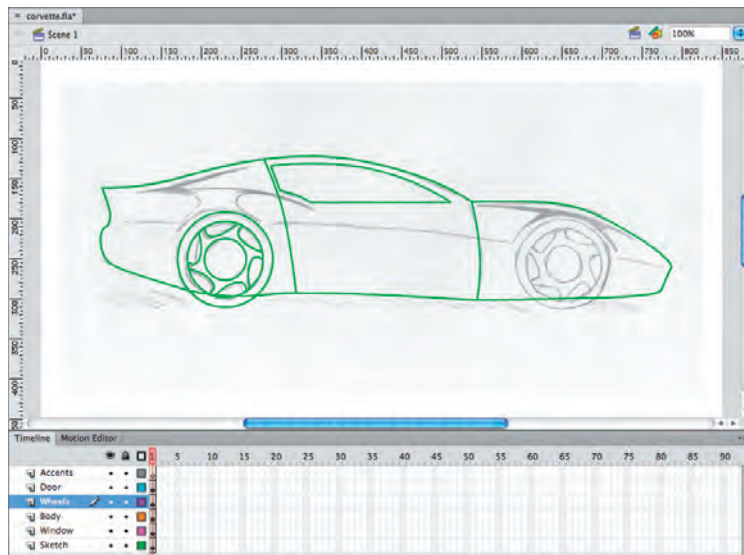

Note:

It's always a good idea to look for ways to avoid duplicating work. You will create the second wheel by duplicating the first wheel after you fill it with color.

11. Save the file and continue to the next stage of the project.

Stage 3 Painting and Coloring Objects

You now have all of the primary shapes you need for this project, clearly organized on separate layers. (You will create the front wheel later by duplicating the finished back wheel.) You drew all of these shapes as unfilled objects so you could see the underlying sketch; now you can apply fill colors to the various shapes. You can use a wide variety of methods to paint the car; you will explore these options in this stage of the project.



APPLY FILL AND STROKE COLORS TO SELECTED SHAPES

The most basic way to change an object's color attributes is simply to select the object and then define the appropriate colors — which you will do in this exercise.

1. With **corvette fla** open, click the **Body** layer icon in the **Timeline** panel.

Remember, clicking a layer icon selects all objects on that layer.

2. Click the Fill Color swatch in the Tools panel and choose a dark red color from the pop-up Swatches panel.

When you change the fill or stroke color when an object is already selected, you affect the relevant attributes of the selected object.

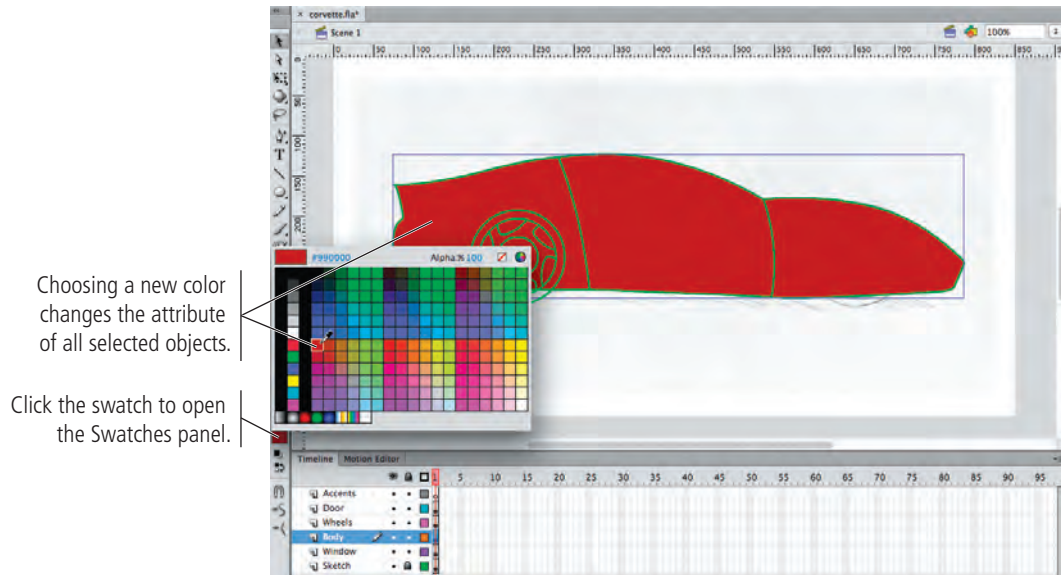

3. With the car shape still selected, click the Stroke Color swatch in the Tools panel and choose the None swatch.

This removes the green lines which were only necessary for the original drawing process.

4. Review the layers in the Timeline panel.

The layer stacking order shows that the window is below the car body. Because the car shape now has a solid fill, you can no longer see the window shape.

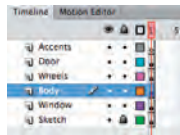

5. Click the Window layer in the Timeline panel and drag up. When a line appears above the Body layer, release the mouse button.

Rearranging the layer stacking order is as simple as clicking and dragging. When the Window layer is above the Body layer, you can again see the window shape.

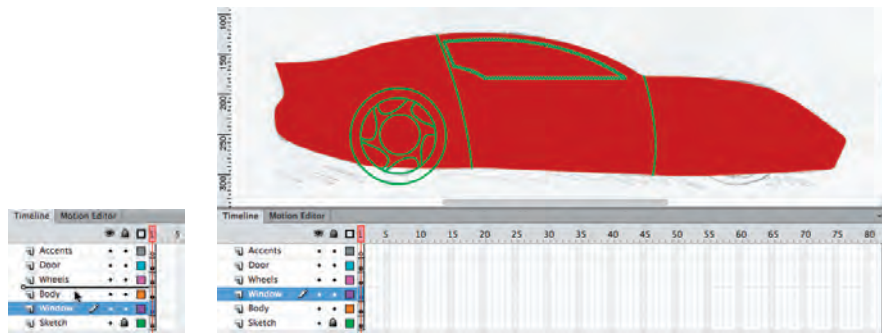

6. Save the file and continue to the next exercise.

FILL ARTWORK WITH THE PAINT BUCKET TOOL

The Paint Bucket tool provides an easy way to change objects' fill colors without first selecting the target objects. In this exercise you will use the Paint Bucket tool to change the fill colors of the window and the wheel.

1. With **corvette.fla** open, make sure nothing is selected on the Stage.

If you change the Fill or Swatch color when an object is selected, the new color will affect the selected object.

2. Choose the Paint Bucket tool in the Tools panel.

3. Use the Fill Color swatch in either the Tools panel or the Properties panel to change the Fill color to Black.

4. Click the Gap Size button at the bottom of the Tools panel and choose Close Large Gaps.

The Gap Size menu allows Flash to overlook slight openings between line segments, which is a common occurrence when you draw with tools such as the Pencil or Line tool. Because you want all of these objects to be solid fills, you are using the largest setting to allow the application to fill the areas that you have defined.

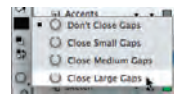

5. Click the line that identifies the window shape to fill the shape with the defined fill color.

Because the object doesn't yet have a fill color, you have to click exactly on the existing line to fill the closed shape. If you clicked inside the shape, the tool would recognize the fill color of the body shape and change its fill to black.

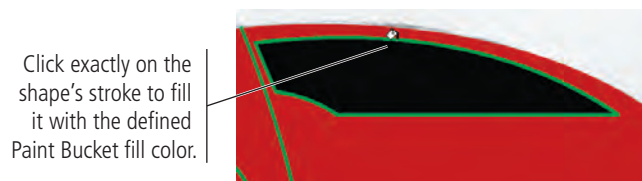

Note:

If you change the wrong object (on a different layer), press Command/Control-Z to undo the last step, and click again to edit a specific object.

Some users prefer to lock all but the layer currently being edited, to prevent changes to objects other than the one you targeted.

6. Using the Selection tool, double-click the wheel group to enter into the group.

You have to enter into the group to edit the properties of individual group components.

7. Choose the Paint Bucket tool again.

8. Click between the outer and middle circles of the wheel shape to change the fill color to black.

In this case, you are editing only the group. There are no other objects on the group's Stage, so the Paint Bucket tool recognizes the closed area between the two circles and adds the black fill color.

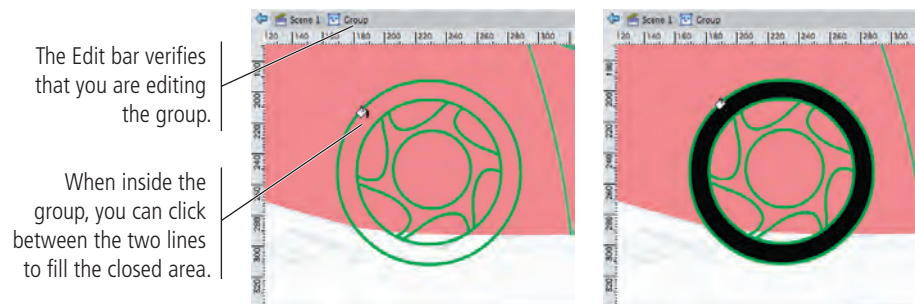

9. Click inside the center circle, and then click inside each of the inset shapes to change all of those fills to black (as shown in the image after Step 10).
10. Change the fill color to medium gray, and then click inside the remaining shape (around the wheel insets) to fill that area with gray.

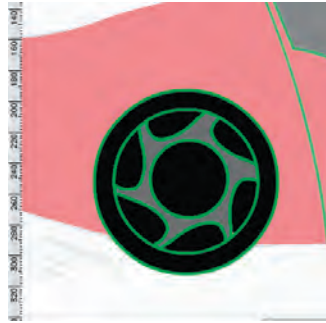

11. Click Scene 1 in the Edit bar to return to the main Stage.
12. Save the file and continue to the next exercise.

CHANGE STROKE ATTRIBUTES WITH THE INK BOTTLE TOOL

The Ink Bottle tool allows you to change the color of strokes without first selecting a specific object. Any stroke you click will be affected by the defined tool settings. In this exercise you will change the bright green strokes that you used during development to something that more accurately suits the project artwork.

1. With `corvette fla` open, choose **Edit>Deselect All** to deselect everything.
2. Choose the **Ink Bottle tool** (under the **Paint Bucket tool**), change the stroke color to black, and change the stroke height to 1 pt.

Once you select the Ink Bottle tool, you can use the Properties panel to predetermine the weight, color, stroke style, and other features before you use the tool. The current settings in the Properties panel will be applied to any shape you click with the Ink Bottle tool, and will remain in effect until you change them.

3. Click inside the **Window shape** to change the object's stroke color to black.

The stroke instantly changes to the new color; it doesn't matter if you select the layer or not. Since all objects are on unlocked layers, the Ink Bottle tool "knows" which objects it's touching.

Note:

When either selection tool is active, you can also simply click an empty area of the Stage to deselect everything in the file.

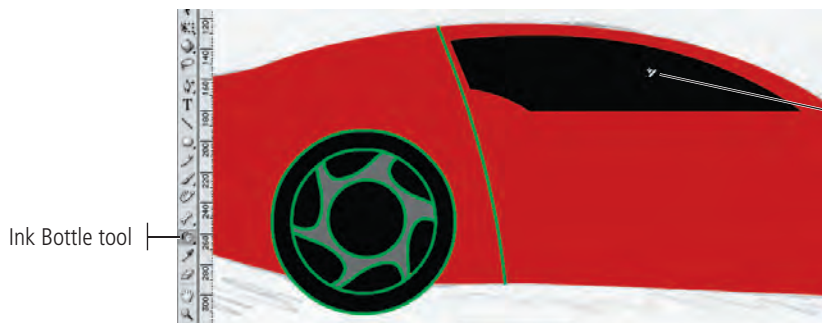

You can click the Ink Bottle tool inside a filled shape to change the object's stroke attributes.

4. With the Ink Bottle tool still selected, click directly on each line that marks the front and back of the car door.

When an object has an existing fill, you can click with the Ink Bottle tool anywhere in the object's fill to change the stroke attributes. If an object has no defined fill, you have to click on the existing stroke to change its attributes.

To accomplish this step, it might help to zoom into the lines you want to change.

Note:

You don't need to select the objects before clicking with the Ink Bottle tool to change the stroke color.

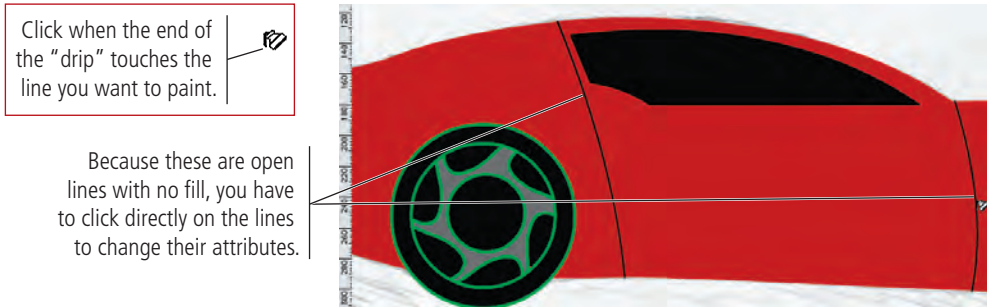

5. Zoom in to the top of the rear door line and review the results.

Because you removed the stroke from the body shape, the "door" lines now hang a bit past the edge of the body shape. You can fix that by adjusting the end-cap style of the door lines.



6. Select the door line with the Selection tool. In the Properties panel, choose None in the Cap menu.

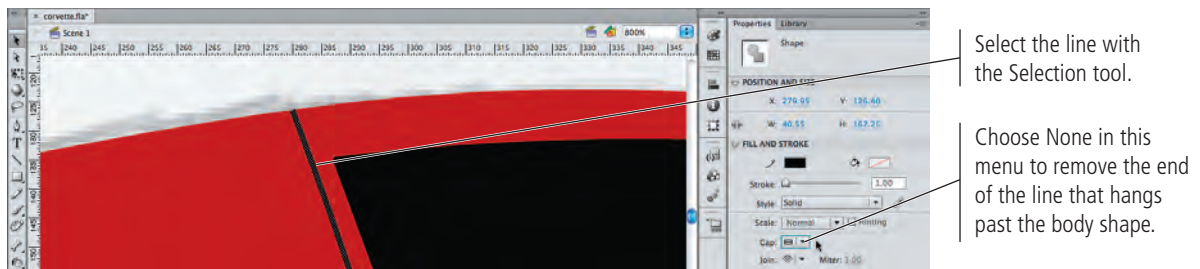

7. Repeat Step 6 for the line that marks the front of the door.

8. Using the Selection tool, double-click the wheel group to enter into the group.

9. Choose the Ink Bottle tool again and change the stroke color to medium gray.

10. Click exactly on the edge of the middle circle.

When you used the destructive editing functionality to create the inset shapes, a number of anchor points were added to the circle shape to create the inset pieces. You need to click the circle edge between and within every inset piece to change the entire stroke to gray.



11. Continue clicking around the circle until the entire middle circle has a 1-pt gray stroke.



12. Change the stroke color to black and then click all of the remaining green strokes in the wheel to change them to black.

In this case, you have to click the actual strokes. If you clicked the fills, you might inadvertently change the gray stroke of the middle circle back to black.



13. Click Scene 1 in the Edit bar to return to the main Stage.

14. Using the Selection tool, click the wheel group, press Option/Alt, and drag right until the duplicate wheel aligns with the front wheel.

Pressing Option/Alt while dragging **clones** (makes a copy of) the object you drag.

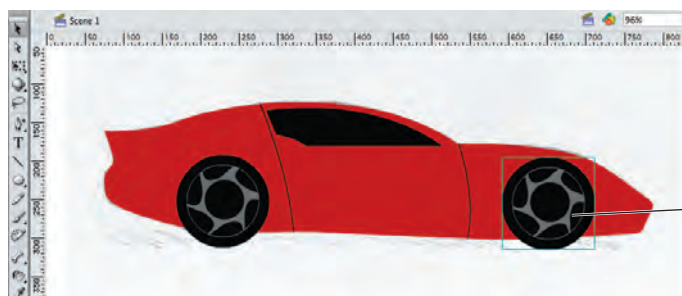

Option/Alt-dragging an object makes an exact copy (called cloning).

Note:

Be careful while making copies of any object. Do not release the Option/Alt key before releasing the mouse. Doing so might move the original object instead of making a copy.

15. Save the file and continue to the next exercise.



ADJUST ALPHA TRANSPARENCY

The Alpha property defines the degree of transparency of an object; in other words, it determines how much you can see underlying objects through another object. This can be useful for creating special effects, including the appearance of depth. In this exercise you will adjust alpha values to create the appearance of reflections on the car's surface.

1. With **corvette fla** open, click the **Outline** button for the **Body** layer so you can see the underlying sketch. Select the **Accents** layer as the active one.

Outline mode allows you to see through filled artwork without changing the objects' fill properties. All objects on outlined layers appear as simple lines that match that layer's defined color swatch; defined fill and stroke attributes are not visible.

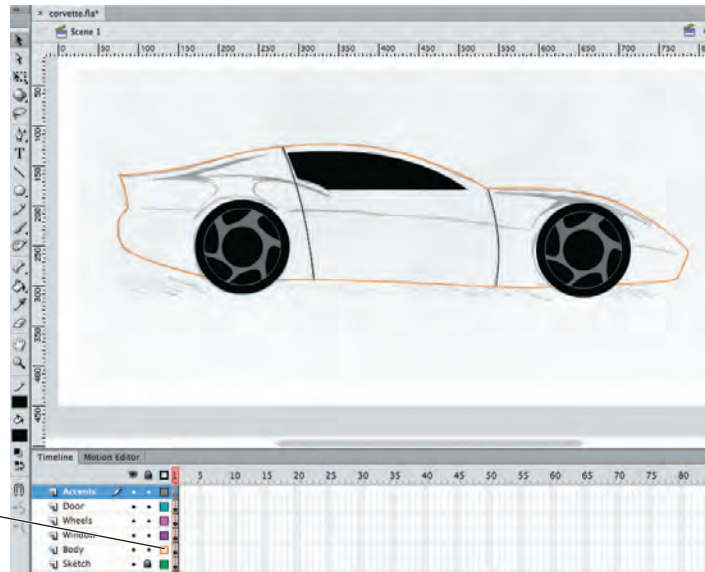

2. Use any tool you prefer (with object-drawing mode toggled on) to create the two curved shapes that represent reflections on the car's upper body.
3. In the Timeline panel, click the **Outline** button for the **Body** layer to restore the layer to the regular view.
4. Select both of the accent shapes and apply a white fill and no stroke.

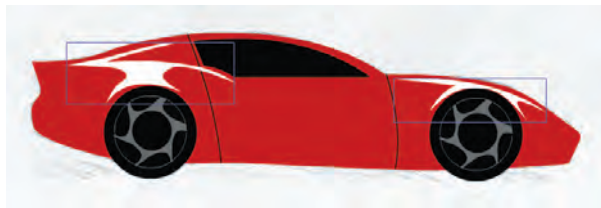

5. In the **Color** panel, click the **Fill Color** swatch to open the color palette.

Remember, all panels can be accessed in the **Window** menu.

- Place the cursor over the Alpha value (in the top-right corner of the palette) until you see a two-headed arrow in the hand icon.

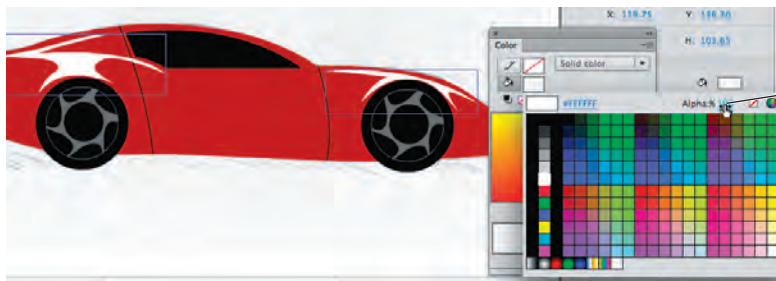

When you see this cursor, you can click and drag left or right to change the associated value (called "scrubbing").

- Click and drag left to reduce the Alpha value to 50%.

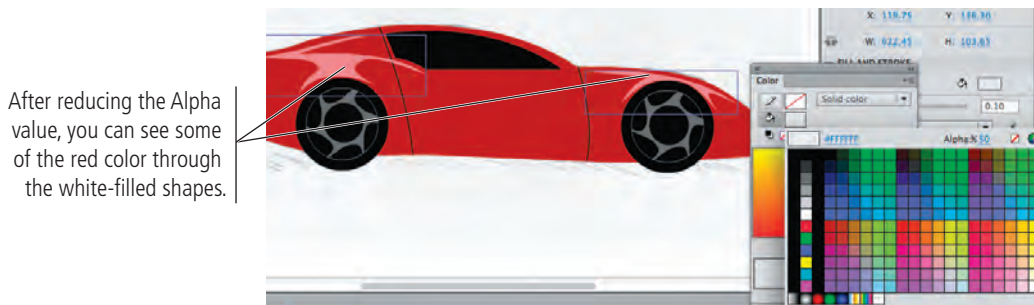

- Save the file and continue to the next exercise.

CONVERT STROKES TO SOFTENED FILLS

The sketch in this project shows three lines that seem to bisect the car, creating an edge that catches the reflection of light. In this exercise, you will create these lines and then adjust them to add depth and texture to the artwork.

- With `corvette fla` open, click the Outline icon for the Body layer so you can see the underlying sketch. Make sure the Accents layer is the active one.
- Choose the Line tool in the Tools panel and activate object-drawing mode. Change the stroke color to white with a 50% Alpha value, and set the stroke height to 1 pt.
- Draw the three lines on the car that seem to bisect the car horizontally. Use the Selection tool to position and bend the lines as necessary.
- Click the Outline button for the Body layer to restore it to the normal view.

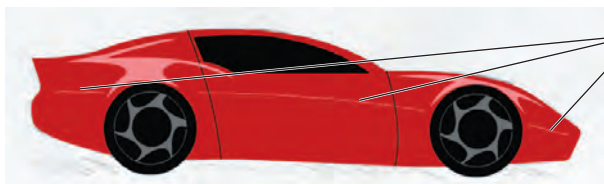

- Using the Selection tool, Shift-click to select all three lines.

6. Choose **Modify>Shape>Convert Lines to Fills**.

These hard-edged lines appear rather harsh; you are going to modify these lines to more smoothly blend into the underlying shape. To do this, you first need to convert the strokes to filled shapes. The fill of the new shapes adopts the stroke color that was applied to the original line.

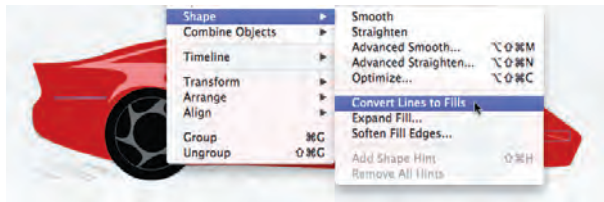

7. With the three lines still selected, choose **Modify>Shape>Soften Fill Edges**.

8. In the resulting dialog box, set the **Distance** field to **2 px** and set the **Number of Steps** field to **4**. Choose the **Expand** option.



9. Click **OK** to apply the change.

Each edge of the shape is now extended by 2 pixels, moving in four steps from the original alpha value (50%) to 0%, or entirely transparent.



Before converting to a fill



After converting to a fill



After softening edges

10. Save the file and continue to the next exercise.

Using the Eyedropper Tool

FLASH FOUNDATIONS

The Eyedropper tool makes it very easy to choose colors from existing objects on the Stage (called **sampling**). Clicking with the tool cursor pulls the color from the exact pixel where you click.

If you sample color from the fill of an object or from a raster image, the tool automatically switches to the Paint Bucket tool loaded with the sampled color.

If you sample color from an existing object's stroke, the tool automatically switches to the Ink Bottle tool loaded with the sampled color.

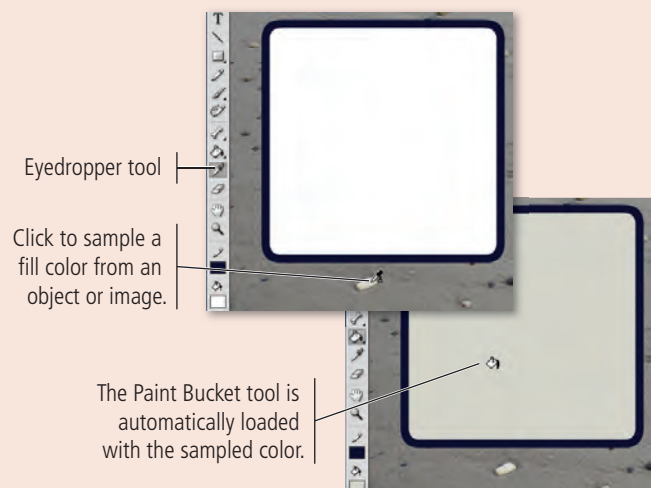



PAINT WITH THE BRUSH TOOL

The Brush tool, as you might expect, is used to paint areas of color. This tool offers a number of modes that allow you to paint in only specific areas, as you will do in this exercise to create a shadow underneath the car.

1. With **corvette.fla** open, select the **Body** layer as the active one.
2. Click away from the artwork on the Stage to deselect everything.
3. Choose the **Brush** tool, change the fill color to a medium gray, and set the Alpha value to 100%.
4. At the bottom of the Tools panel, click the **Brush Mode** menu and choose **Paint Behind**.

The Brush tool has five modes:

- **Paint Normal** is exactly that: it paints on top of anything already on the Stage.
- Using the **Paint Fills** mode, you paint over the background and any object fills, but you leave object strokes unaffected.
- **Paint Behind** allows you to paint only the background; any area with a fill or stroke remains unaffected by the brush stroke.
- **Paint Selection** applies your brush strokes to currently selected fill areas only.
- **Paint Inside** applies the brush stroke within the boundaries of the fill where you first click.

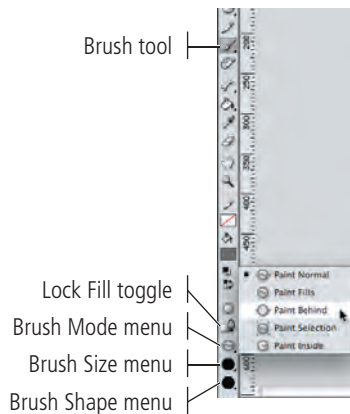

Note:

The tool options remember the last-used settings, so some of these might already be set to the options we use in this exercise.

5. Click the **Brush Size** button and choose the largest available brush.
6. Click the **Brush Shape** button and choose the full round option.

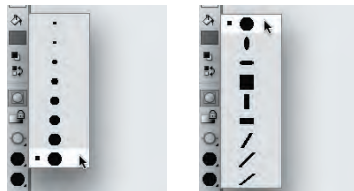

7. Using the sketch as a rough guide, click and drag to paint a shadow shape underneath the car.

Don't worry about overlapping the car body shape while you're painting the shadow; although it appears to be on top of (and obscuring) the car shape, the shadow assumes its proper place behind the body when you release the mouse button.

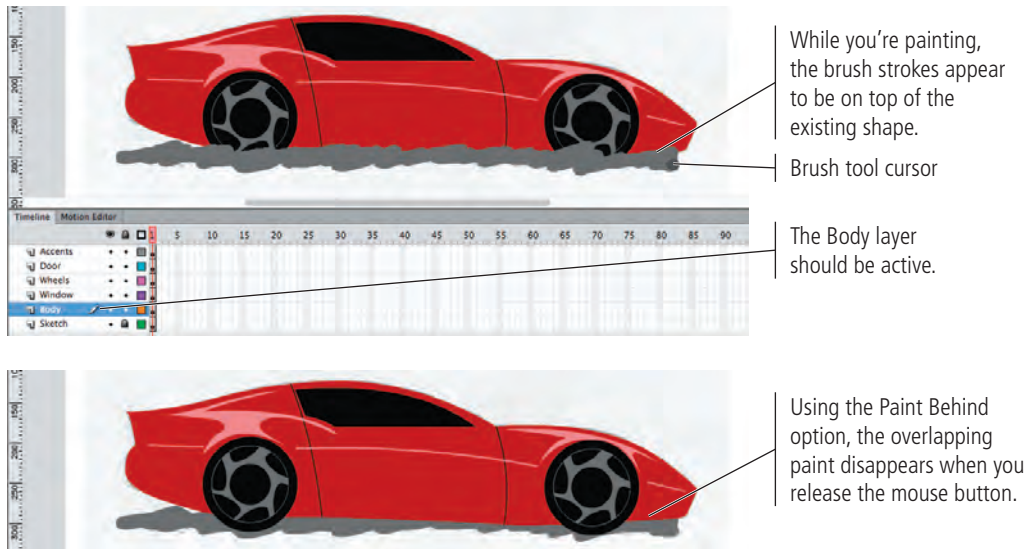

8. Using the Selection tool, select the shadow shape and then choose Edit>Cut.

9. In the Timeline panel, click the New Layer button. Name the new layer **Shadow.**

As we explained previously, new layers are always added immediately above the previously selected layer.

10. With the Shadow layer selected, choose Edit>Paste in Place.

Even though you couldn't see the entire brush stroke after releasing the mouse button, the shape exactly matches the area that you painted. When moved to a higher layer in the stack, the entire area becomes visible — obscuring some of the car body.

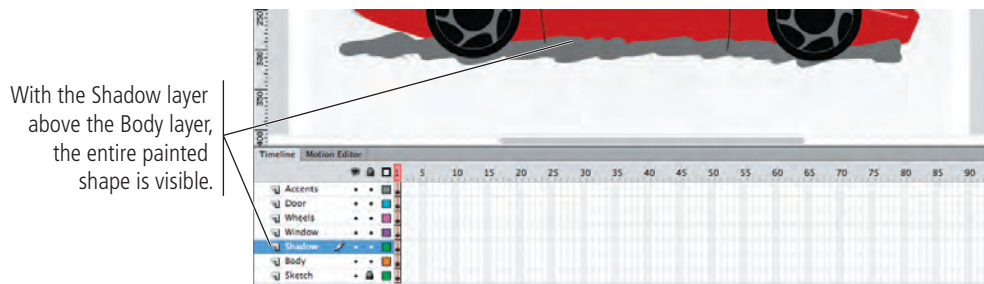

11. Click the Shadow layer in the Timeline panel and drag it below the Body layer.

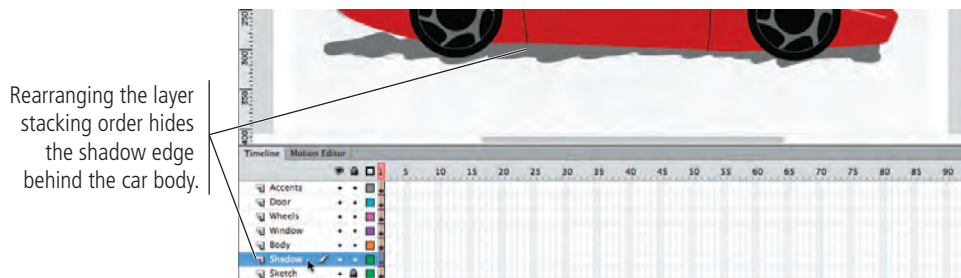

12. Save the file and continue to the next exercise.

APPLY LINEAR AND RADIAL GRADIENTS

At this point your artwork is a technically complete piece of artwork; all of the shapes are in place, with the necessary solid fills and strokes to clearly portray a digital Corvette. To add greater depth and dimension, however, you are going to apply gradients to the car's body and window.

1. With `corvette fla` open, click the window shape with the Selection tool.
2. Using either the Properties or Tools panel, open the Fill Color palette and choose the white-to-black radial gradient swatch.

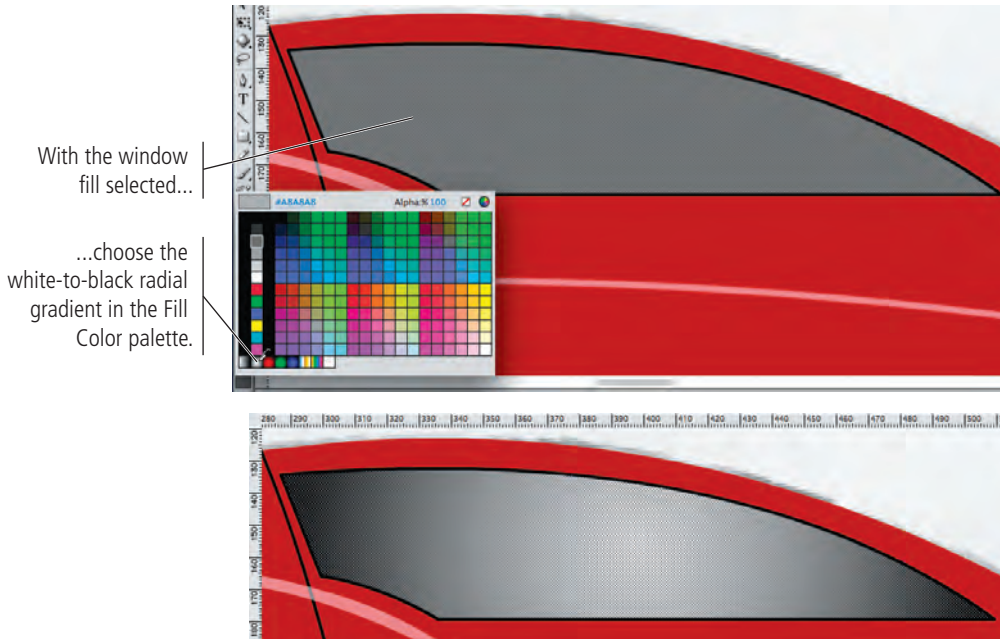

3. In the Color panel, click below the gradient ramp near the middle to add a new color stop to the gradient.

Clicking below the ramp adds a new stop, which defaults to the color of the location where you first click.



4. Drag the new stop left, to approximately one-fourth of the way across the ramp.

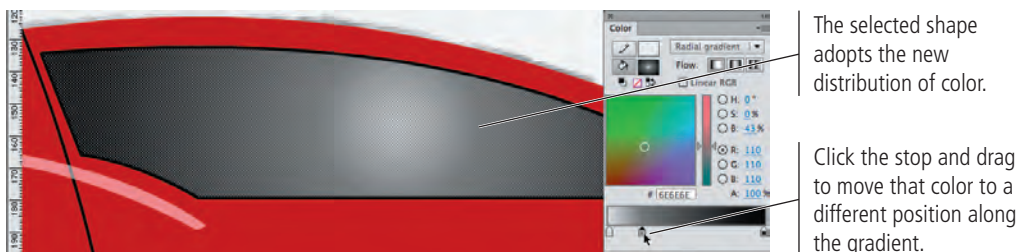

Note:

Artwork that contains only solid fills is referred to as flat art.

Note:

The terms "gradient" and "blend" are used interchangeably. Flash documentation uses both gradient and blend; both terms mean a smooth transition from one color to another.

Note:

You can define up to 15 color stops in a single gradient.

5. Click the car body shape with the Selection tool.
6. In the Color panel, click the Fill Color icon to activate that attribute.
7. In the Color Type menu, choose Linear Gradient.

The gradient ramp remembers the last-used gradient, so the adjusted white-to-black gradient from the window is applied to the selected shape (the car body).



8. At the bottom of the Color panel, click the color stop in the middle of the gradient ramp and drag down away from the ramp.

You can remove any stop from a gradient by simply dragging it away from the ramp.

9. Double-click the color stop at the left end of the gradient ramp. Choose the dark red color swatch from the pop-up palette.

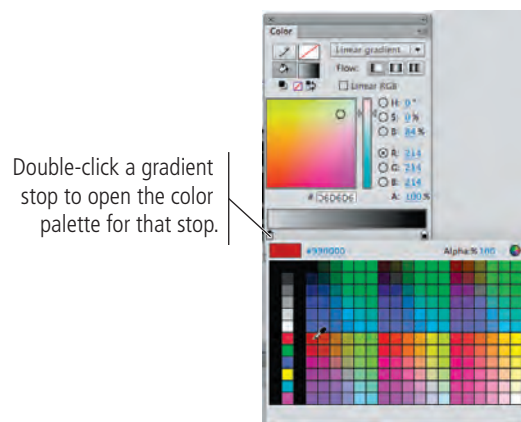

10. Double-click the right color stop and choose the same dark red color that you applied to the left stop.
11. With the right stop still selected, drag the Brightness slider in the Color panel down until the B% option (in the HSB group) shows 10%.

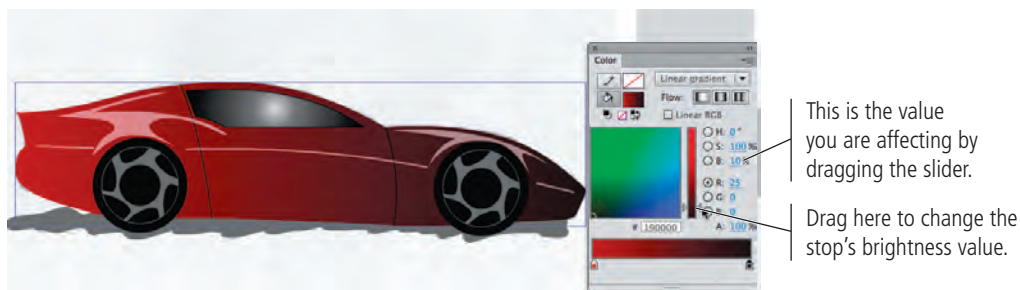

12. Save the file and continue to the next exercise.



TRANSFORM GRADIENTS

As you saw in the previous exercise, it is fairly easy to apply gradients to any drawing object, and to change the colors that are used in those gradients. Of course, the left-to-right gradient on the car's body does not create the realistic effect that you want. You now need to transform the applied gradients to finish the piece.

1. With **corvette.fla** open, choose the **Gradient Transform tool** (nested under the **Free Transform tool**).
2. Click the window shape to select it.

The Gradient Transform tool enables you to adjust the size, direction, and center point of a gradient fill. When you click an object filled with a gradient, a special bounding box shows the gradient-editing handles.

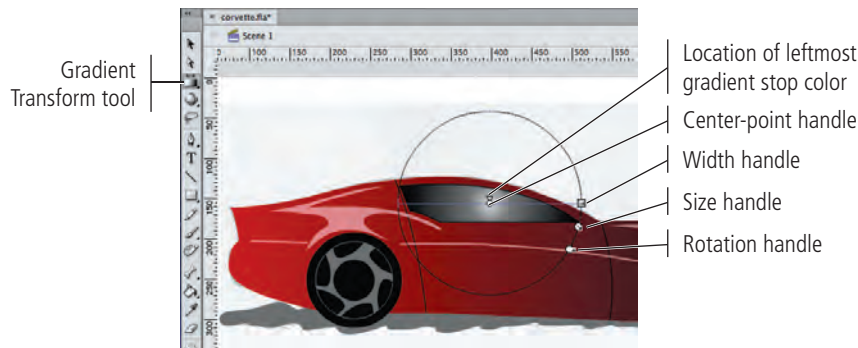

3. Click the **center point of the gradient** and drag to the **top-left corner of the window shape**.

Dragging the center-point handle moves the center of the gradient to a new location.

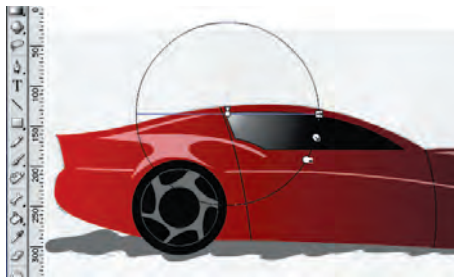

4. Click the **gradient-width handle** and drag in about **halfway to flatten the gradient**.

Dragging the width handle of a radial gradient makes the gradient narrower or wider in one direction, essentially creating a skewed effect.

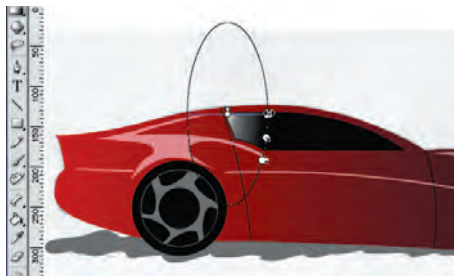

5. Click the gradient-rotation handle and drag left to change the angle of the gradient.

Dragging the rotation handle rotates the gradient around its center point.



6. Click the gradient-size handle and drag out to enlarge the adjusted gradient.

Dragging the size handle makes the overall gradient larger or smaller in both directions (without affecting the gradient's aspect ratio).

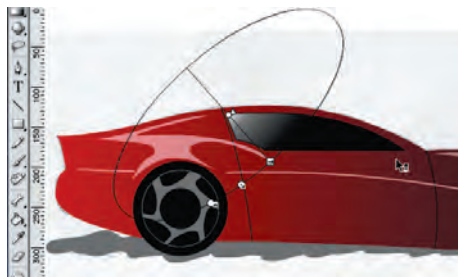

7. Still using the Gradient Transform tool, click the car body shape to select it and access the gradient transformation handles.

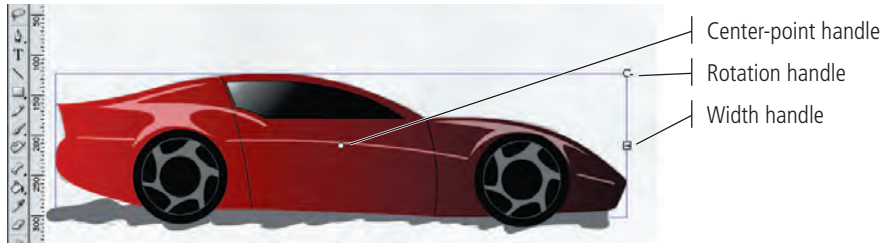

8. Click the gradient-rotation handle and drag down and left to rotate the gradient approximately 90°, with the dark part of the gradient toward the bottom edge of the car.

Because you did not yet change the gradient width, the rotated gradient transformation handles will be well below the Stage edge. If necessary, zoom out so you can see all the gradient transformation handles.

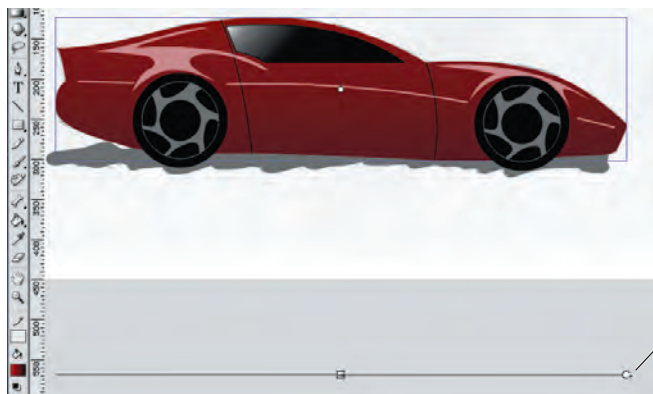

The gradient transformation handles are below the Stage edge because you have not yet changed the gradient width.

Note:

You can use the rotation handle to reverse a gradient. Simply drag all the way around (180°) until the gradient colors are reversed.

- Click the gradient-width handle and drag up until the gradient is just slightly larger than the height of your artwork.

For a linear gradient, dragging the width handle makes the gradient narrower or wider.

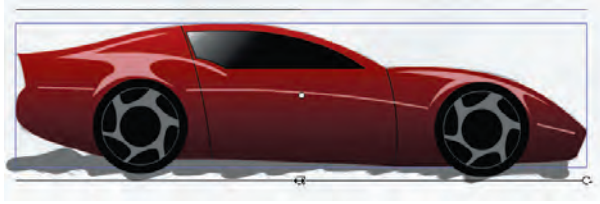

- Click the center point of the gradient and drag down, about one-third of the way closer to the bottom of the car body.

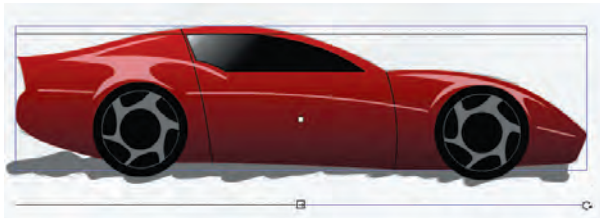

- Save the file and continue to the next exercise.

Locking Bitmap and Gradient Fills

FLASH FOUNDATIONS

You can use a bitmap (raster) image as the fill of an object by choosing Bitmap Fill in the Fill Type menu of the Color panel. All available bitmap files appear as tiles in the lower half of the panel; if none are available, choosing Bitmap Fill in the menu opens a dialog box, where you can import the file you want to use.

You can use the Paint Bucket tool to fill an existing object with a bitmap, or you can use the Brush tool to paint the bitmap onto the Stage. The **Lock Fill** modifier at the bottom of the Tools panel determines how the fill will be added.

- When toggled on, the selected bitmap image is tiled inside the shape.
- When toggled off, the selected bitmap image is basically pasted to the Stage. The filled area essentially "reveals" the area of the selected bitmap image. (If a bitmap-fill image is too small to fill the Stage, the image is tiled as necessary)

Lock Fill modifier

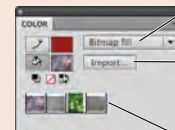

Choose Bitmap Fill in this menu.

Click Import to add bitmaps to the file.

Click any available tile to select that bitmap as the fill.

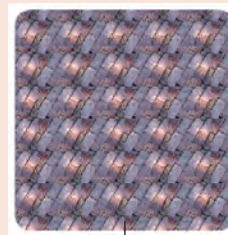

Turned on, the bitmap image is tiled inside the filled shape



Turned off, the shape reveals the relevant area of the bitmap.

If you select a bitmap-filled object with the Gradient Transform tool, you can edit the size, skew, rotation, and position of the fill image.

Similar Lock Fill options are available when you work with gradients. When this option is toggled on, the gradient is applied relative to the overall Stage; filled areas reveal the relevant area of the gradient. If the option is turned off, the gradient is applied to each object independently.

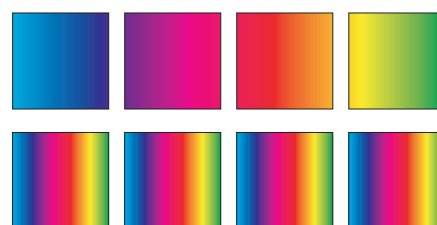

With the Lock Fill modifier, the same gradient extends across all four squares.

Without the Lock Fill modifier, the gradient is applied individually to each square.

ORGANIZE FINISHED ARTWORK LAYERS

A Flash project can contain dozens of layers representing the various components of the animation or movie. To organize all of these layers into logical groups or categories, you can use layer folders.

1. With `corvette.fla` open, select the top layer (Accents) in the Timeline panel.
2. Click the New Folder button at the bottom of the Timeline panel.

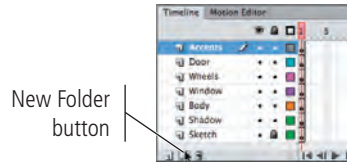

3. Double-click the new folder name. Type **Car Parts** as the new folder name and press Return/Enter to finalize the new name.

You change the name of a layer folder the same way you change the name of a layer; simply double-click the folder name and type in the new name.

4. Click the Accents layer to select it, then Shift-click the Shadow layer to add it and all contiguous layers to the selection.
5. Click any of the selected layers and drag them into the Car Parts folder.

The dragged layers now reside inside the layer folder, which makes it easier to treat the entire group of layers as a single object. This will be helpful later when the artwork is used in programming and interactive development.



6. Click the Lock column for the Car Parts folder.

By locking the layer folder, you have effectively locked each layer inside the folder (although you can unlock individual layers in the folder by clicking that layer's Lock icon). The same concept is true of the Visibility and Outline buttons for the layer folder.

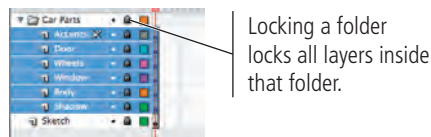

7. Click the arrow to the left of the Car Parts folder to collapse it.

Once collapsed, only the layer folder is visible. This makes it easier to navigate through the Timeline panel, which can grow very large for complex projects.

8. Select the Sketch layer and click the panel's Delete button.

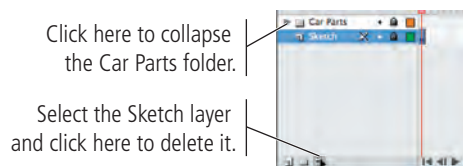

9. Save the file and continue to the final exercise.

Note:

You can rename layer folders in the same way you rename layers, and you can reorder layer folders (and their contents) by dragging the folders into new positions in the layer stack.

Note:

Press Shift to select contiguous layers — that is, layers directly on top of or below one another. To select layers that aren't next to each other, press the Command/Control key while clicking the individual (non-contiguous) layers.

Note:

When you use layer folders, you can lock and hide all the contents in the folder by locking and hiding the entire folder.



EXPORT ARTWORK AS AN IMAGE

Instead of sending the Flash file to your client, you are going to export a static image that can be easily reviewed by anyone with a Web browser. Flash includes the ability to export a number of different static image formats, including JPEG, GIF, Adobe FXG (Flash XML Graphics), PNG, and BMP (Windows only).

1. With `corvette fla` open, choose `File>Export>Export Image`. Navigate to your `WIP>Car` folder as the target location.

2. Add `_drawing` to the end of the existing file name (before the file extension).

On Windows, the file extension might not be visible in the document window. If this is the case, simply type after the existing file name.

3. Choose `JPEG Image` in the `Format/Save As Type` menu, then click `Save`.

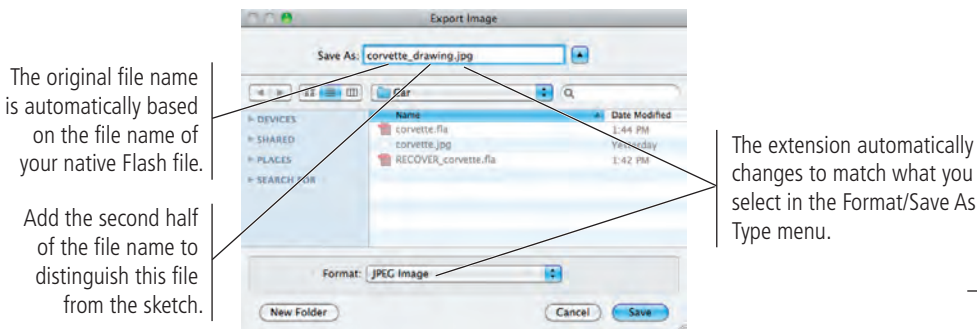

4. In the resulting `Export JPEG` dialog box, make sure the `Resolution` option is set to `72 dpi`.

You are creating this image for on-screen review, so 72 dpi is fine. If you needed the artwork for high-quality printing, you should use a higher resolution (i.e., 300 dpi).

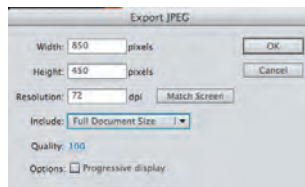

5. Choose `Full Document Size` in the `Include` menu.

If you choose `Minimum Image Area`, the exported image will be only and exactly as large as the outermost edges of the artwork. The `Full Document Size` option creates a file that matches the defined Stage size.

6. Change the `Quality` value to `100%`.

Reducing the `Quality` value will result in a smaller file size, but can significantly decrease the resulting image quality (especially in complex artwork). For review purposes, the highest possible quality setting is a better option.

7. Click `OK` to export the `JPEG` file.

8. Close the `corvette fla` file.

Note:

Flash should generally not be used for developing artwork for high-quality commercial print applications.

Note:

You can click the `Match Screen` button to restore the size and resolution fields to match what you see on your monitor.

Note:

If the `Progressive Display` option is checked, the image will appear in progressive degrees of detail as it downloads.

Project Review

fill in the blank

1. The _____ can be used to change the size of the Stage.
2. _____ in the Timeline panel can be used to manage the top-to-bottom order of objects on the Stage.
3. When created in _____, the fill and stroke are treated as separate entities; you can individually select each part, and move or modify each part without affecting the other.
4. When you create a shape in _____, it automatically displays the bounding box as soon as you create it; you can't select the fill and stroke independently on the main Stage.
5. A(n) _____ allows multiple objects to be treated as a single entity on the Stage.
6. The _____ tool can be used to select areas of a standard-drawing object, or to bend lines created in either drawing mode.
7. The _____ tool can be used to select individual anchor points and handles that make up a shape.
8. The _____ tool is used to create precise Bézier curves.
9. The _____ tool is used to change the fill color of closed shapes.
10. The _____ tool is used to change the stroke color of any object.

short answer

1. Briefly explain how anchor points and handles control the lines in a vector shape.
2. Briefly explain the difference between the Selection tool and the Subselection tool.
3. Briefly explain what is meant by "destructive editing."

Project Summary

Although Flash is known as an animation program, you can see from this project that the application offers a considerable array of drawing and painting tools. You learned how to import a sketch, control the size of the Flash Stage, and align objects to the Stage. These skills set the groundwork for any type of assignment. You also developed an understanding of layers and how they simplify the construction of complex drawings and artwork.

Flash includes a range of drawing tools — from the basic shape tools, the Line tool for simple lines, and the Pen and Pencil tools for more complex curves. Those tools, combined with the two Flash drawing modes and the unique destructive editing capabilities that are part of the Flash toolset, make it possible to create complex artwork directly on the Stage.

