

International Symbols

Biotech Services manages large-scale manufacturing facilities specializing in everything from digital photographic equipment to large earth-moving machines used to build new roads. The company builds plants all over the world that in many cases handle dangerous chemicals and undertake dangerous tasks — which means they must prominently display appropriate warnings. Biotech Services hired you to create a digital collection of universal symbols that they can use to create signs, print on the side of large machines, place as icons on their Web sites, and embroider onto employee uniforms.

This project incorporates the following skills:

- Placing raster images into an Illustrator file to use as drawing templates
- Creating and managing simple shapes and lines
- Using various tools and panels to transform objects' color, position, and shape
- Cloning objects to minimize repetitive tasks
- Using layers to organize and manage complex artwork
- Drawing complex shapes by combining simple shapes



Project Meeting

client comments

We have a set of universal warning symbols on our Web site, but we need to use those same icons in other places as well. Our printer told us that the symbols on our Web site are “low res,” so they can’t be used for print projects. The printer also said he needs vector graphics that will scale larger and still look good. The printer suggested we hire a designer to create digital versions of the icons so we can use them for a wide variety of purposes, from large machinery signs to small plastic cards to anything else that might come up. We need you to help us figure out exactly what we need and then create the icons for us.

art director comments

Basically, we have the icons, but they’re low-resolution raster images, so they only work for the Web, and they can’t be enlarged. The good news is that you can use the existing icons as templates and more or less trace them to create the new icons.

The client needs files that can be printed cleanly and scaled from a couple of inches up to several feet. Illustrator vector files are perfect for this type of job. In fact, vector graphics get their resolution from the printer being used for a specific job, so you can scale them to any size you want without losing quality.

project objectives

To complete this project, you will:

- Create a grid that will eventually hold all icons in one document
- Control objects’ stroke, fill, and transparency attributes
- Import and use the client’s raster images as templates, which you can then trace
- Use layers to manage complex artwork
- Use the Line Segment tool to create a complex object from a set of straight lines
- Lock, unlock, hide, and show objects to navigate the objects’ stacking order
- Rotate and reflect objects to create complex artwork from simple shapes
- Use the Pathfinder to combine simple shapes into a single complex object



Stage 1 Setting up the Workspace

There are two primary types of digital artwork: raster images and vector graphics. (**Line art**, sometimes categorized as a third type of image, is actually a type of raster image.)

Raster images are pixel-based, made up of a grid of individual **pixels** (**rasters** or **bits**) in rows and columns (called a **bitmap**). Raster files are **resolution dependent**; their resolution is determined when you scan, photograph, or create the file. As a professional graphic designer, you should have a basic understanding of the following terms and concepts:

- **Pixels per inch (ppi)** is the number of pixels in one horizontal or vertical inch of a digital raster file.
- **Lines per inch (lpi)** is the number of halftone dots produced in a linear inch by a high-resolution imagesetter, which simulates the appearance of continuous-tone color.
- **Dots per inch (dpi)** or **spots per inch (spi)** is the number of dots produced by an output device in a single line of output.

Drawing objects that you create in Illustrator are **vector graphics**, which are composed of mathematical descriptions of a series of lines and points. Vector graphics are **resolution independent**; they can be freely scaled and are automatically output at the resolution of the output device.



CREATE A NEW DOCUMENT

In this project, you work with the basics of creating vector graphics in Illustrator using a number of different drawing tools, adding color, and managing various aspects of your artwork. The first step is to create a new document for building your artwork.

1. **Download Print5_RF_Project1.zip from the Student Files Web page.**
2. **Expand the ZIP archive in your WIP folder (Macintosh) or copy the archive contents into your WIP folder (Windows).**

This results in a folder named **Symbols**, which contains all of the files you need for this project. You should also use this folder to save the files you create in this project.

If necessary, refer to Page 1 of the Interface chapter for specific information on expanding or accessing the required resource files.

3. **In Illustrator, choose File>New.**
4. **In the resulting New Document dialog box, type **icons** in the Name field.**

The New Document dialog box defaults to the last-used settings.

5. **Choose Print in the New Document Profile menu, and make sure the Number of Artboards field is set to 1.**

Illustrator CS5 includes the ability to create multiple **artboards** (basically, Illustrator's version of "pages"). You will work with multiple artboards in Projects 3 and 5.

6. **Choose Letter in the Size menu, choose Points in the Units menu, and choose the Portrait Orientation option.**

The **point** is a standard unit of measurement for graphic designers. There are 72 points in an inch. As you complete this project, you will work with other units of measurement; you will convert the units later.

7. Set all four bleed values to 0.

Bleed is the amount an object needs to extend past the edge of the artboard or page to meet the mechanical requirements of commercial printing.

8. If the Advanced options aren't visible, click the arrow button to the left of the word Advanced.

9. Make sure the Color Mode is set to CMYK and the Preview Mode is set to Default.

CMYK is the standard color mode for printing, and RGB is the standard color mode for digital distribution. You learn much more about color and color modes in Project 2.

Don't worry about the other Advanced options for now. You will learn about those in later projects when they are more relevant.

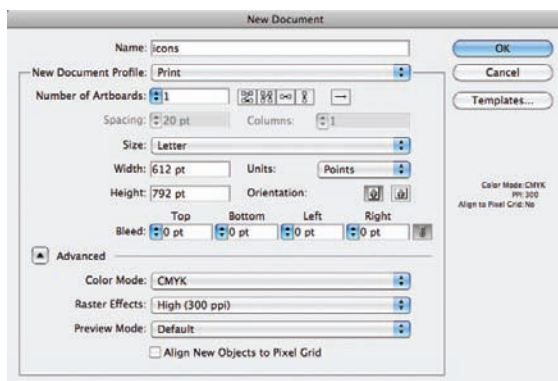

Note:

You learn more about bleeds in Project 3.

10. Click OK to create the new file.

In the resulting document window, the letter-size “page” (or artboard) is represented by a dark black line. The artboard concept will be important in the final stage of this project, when you save the icon files for use in other applications.

As we explained in the Interface chapter, the panels you see depend on what was done the last time you (or someone else) used the application. Because workspace arrangement is such a personal preference, we tell you what panels you need to use, but we don't tell you where to place them. (Remember that panels can be accessed in the Window menu.)

In our screen shots, we typically float panels over the relevant area of the document so we can focus the images on the most important part of the file at any particular point. As you complete the projects in this book, feel free to dock the panels, grouped or ungrouped, iconized or expanded, however you prefer.

Note:

Our screen shots show the Macintosh operating system using the Application frame. If you're on a Macintosh system and your screen doesn't look like our screen shots, choose Window>Application Frame to toggle on that option.

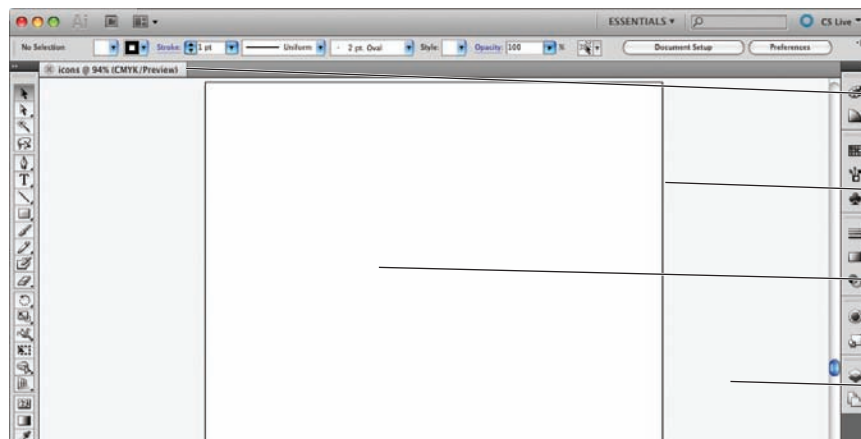

The name you defined appears in the document tab.

This is the artboard edge.

The artboard area is pure white.

The area outside the artboard is slightly grayer than the artboard.

11. Choose File>Save As and navigate to your WIP>Symbols folder.

If you assign a name in the New Document dialog box (as you did in Step 4), that name becomes the default file name in the Save As dialog box.

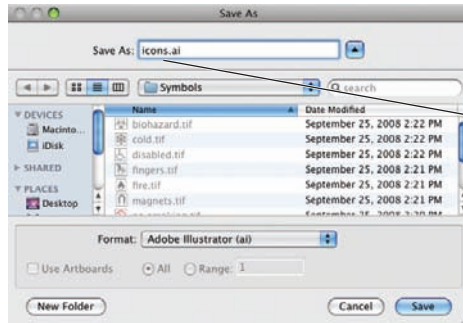

The file name defaults to the name you defined when you created the file, including the ".ai" extension.

Note:

Press Command/Control-S to save a document, or press Command/Control-Shift-S to open the Save As dialog box.

12. Click Save in the Save As dialog box. Review the options in the resulting Illustrator Options dialog box.

This dialog box determines what is stored in the resulting file (the default options are adequate for most files).

- Use the **Version** menu to save files to be compatible with earlier versions of the software. (Keep in mind that many features are not supported by earlier versions; if you save a file for an earlier version, some file information will probably be lost.)
- **Subset Embedded Fonts when Percent of Characters Used Is Less Than** determines when to embed an entire font instead of just the characters that are used in the file. (Embedding the entire font can significantly increase file size.)
- Make sure **Create PDF Compatible File** is checked if you want to use the file with other Adobe applications (such as placing it into an InDesign layout).
- **Include Linked Files** embeds files that are linked to the artwork. (You will learn about linked and embedded files in Project 5.)
- **Embed ICC Profiles** stores color information inside the file for use in a color-managed workflow.
- **Use Compression** compresses PDF data in the Illustrator file.
- **Save Each Artboard to a Separate File** saves each artboard as a separate file; a separate master file with all artboards is also created.
- **Transparency** options determine what happens to transparent objects when you save a file for Illustrator 9.0 or earlier. Preserve Paths discards transparency effects and resets transparent artwork to 100% opacity and Normal blending mode. Preserve Appearance and Overprints preserves overprints that don't interact with transparent objects; overprints that interact with transparent objects are flattened.

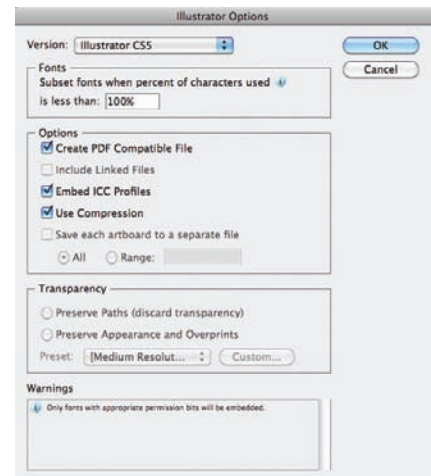

13. Click OK to save the file, and then continue to the next exercise.

DEFINE SMART GUIDE PREFERENCES

Adobe Illustrator provides many tools to help you create precise lines and shapes. **Smart Guides** are temporary snap-to guides that help you create, align, and transform objects. Smart Guides also show you when the cursor is at a precise angle relative to the original position of the object or point you're moving. In this exercise, you will make sure the correct Smart Guides are active.

1. With **icons.ai** open and nothing selected in the file, click the **Preferences** button in the Control panel.



2. Choose **Smart Guides** in the menu at the top of the Preferences dialog box.
3. Make sure the **Alignment Guides**, **Object Highlighting**, **Anchor/Path Labels**, and **Measurement Labels** options are selected and click **OK**.

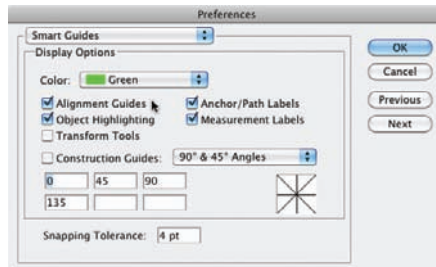

4. Choose **View>Smart Guides** to make sure that option is toggled on (checked).

If the option is already checked, simply move your mouse away from the menu and click to dismiss the menu without changing the active option.



5. Continue to the next exercise.

Note:

When nothing is selected in the file, you can access the Preferences dialog box directly from the Control panel.

If something is selected in the file, you have to choose **Illustrator > Preferences** on Macintosh or **Edit > Preferences** on Windows.

Using Smart Guides

You can change the appearance and behavior of Smart Guides in the Preferences dialog box. The Display options determine what is visible when Smart Guides are active:

- When **Alignment Guides** is active, Smart Guides show when a new or moved object aligns to the center or edge of a nearby object.
- When **Object Highlighting** is active, moving the mouse over any part of an unselected object shows the anchors and paths that make up that object.
- When **Transform Tools** is active, Smart Guides display when you scale, rotate, or shear objects.
- When **Anchor/Path Labels** is active, Smart Guides include labels that show the type of element (path or anchor) under the cursor.

This anchor is being dragged with the Direct Selection tool.

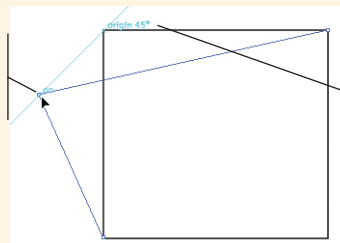

The Smart Guide shows that the anchor is being moved at a 45-degree angle from the original position.

- When **Measurement Labels** is active, Smart Guides show the distance and angle of movement.
- When **Construction Guides** is active, Smart Guides appear when you move objects in the file at or near defined angles (0°, 45°, 90°, and 135° are the default angles). A number of common angle options are built into the related menu, or you can type up to six specific angles in the available fields.

DRAW BASIC SHAPES

Now that you have a place to draw (the artboard), you're ready to start creating the icon artwork. The first step of this project requires a set of background shapes — simple rectangles with rounded corners — to contain each icon. Illustrator includes a number of shape tools that make it easy to create this kind of basic shape — rectangles (or squares), ellipses (or circles), and so on.

1. With `icons.ai` open, click the **Rectangle tool** in the **Tools panel** and hold down the mouse button until the nested tools appear. Choose the **Rounded Rectangle tool** from the list of nested tools.

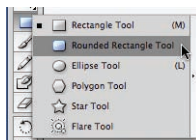

2. Click the **Default Fill and Stroke** button at the bottom of the **Tools panel**.

In Illustrator, the default fill is white and the default stroke is 1-pt black.

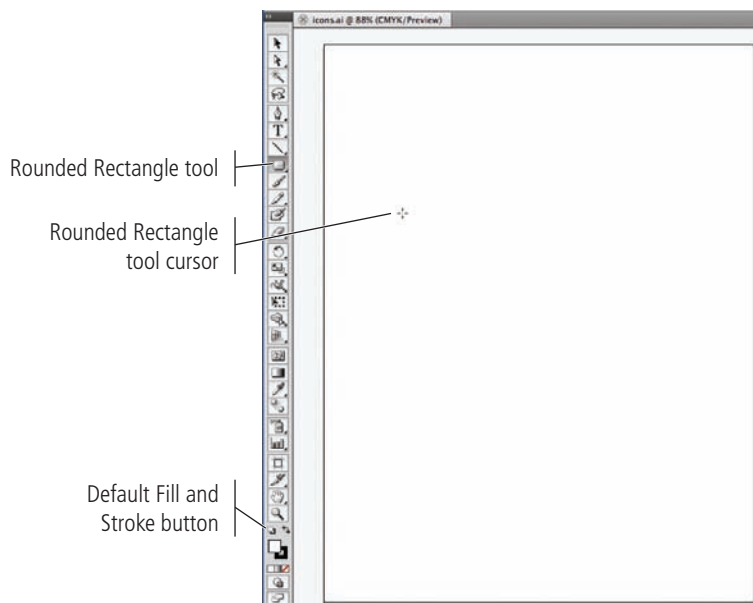

3. Click the **Rounded Rectangle tool** anywhere on the artboard.

The resulting dialog box asks how big you want to make the new rectangle, defaulting to the last-used measurements. The default application measurement system is points; however, it is possible to change the default units, so you might see inches, millimeters, or some other unit on your screen (i.e., if someone changed the default settings).

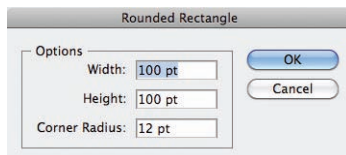

Note:

A point is a unit of measurement that comes from the traditional typesetting industry; there are 72 points in an inch.

Note:

If you Option/Alt-click with any of the shape tools, the place where you click becomes the center of the new shape.

4. Type **1.5"** in the Width field and then press Tab to move to the Height field.

Regardless of what unit you see in the dialog box, you can enter values in whatever system you prefer, as long as you remember to type the correct unit in the dialog box fields (use " for inches, mm for millimeters, and pt for points; there are a few others, but they are rarely used). Illustrator automatically translates one unit of measurement to another.

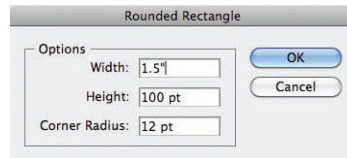

When you move to the next field, Illustrator calculates the conversion of 1.5 inches (the value you placed in the Width field) to 108 pt (the value that automatically appears in the Width field after you move to the Height field).

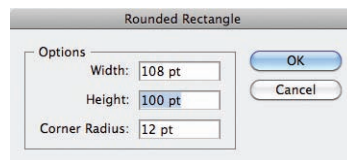

5. Type **1.5"** in the Height field. Set the Corner Radius field to **12 pt**, and then click OK.

A shape appears on the artboard with its top-left corner exactly where you clicked the Rounded Rectangle tool.

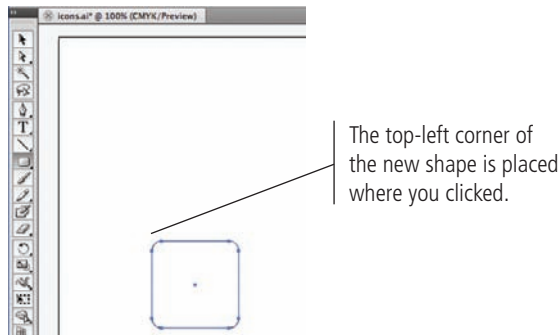

Note:

A rounded-corner rectangle is simply a rectangle with the corners cut at a specific distance from the end (the corner radius). The two sides are connected with one-fourth of a circle, which has a radius equal to the amount of the rounding.

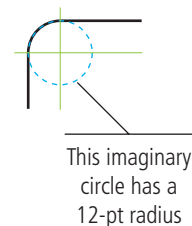

6. Click the Selection tool in the Tools panel and zoom in to 200%.

When the object is selected, the **bounding box** marks the outermost edges of the shape. **Bounding box handles** mark the corners and exact horizontal and vertical center of the shape. If you don't see the bounding box, choose View>Show Bounding Box.

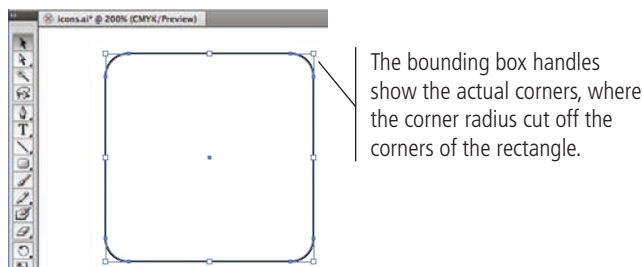

Note:

As a rule, we don't tell you what view percentage to use unless we want to highlight a specific issue. As you work through the projects in this book, we encourage you to zoom in and out as necessary to meet your specific needs.

7. Select the Rounded Rectangle tool in the Tools panel.

When you choose a nested tool, that variation becomes the default option in the Tools panel. You don't need to access the nested menu to select the Rounded Rectangle tool again.

8. Move the cursor to the right of the top edge of the existing shape.
9. When you see a green line connected to the top edge of the first shape, click, hold down the mouse button, and drag down and right to begin creating a second shape. Do not release the mouse button.

The green line is a function of the Smart Guides feature, which provides instant feedback while you draw. As you drag, notice the cursor feedback showing the size of the new shape. Also notice that as you drag near the bottom edge of the first shape, a Smart Guide appears to indicate your position.

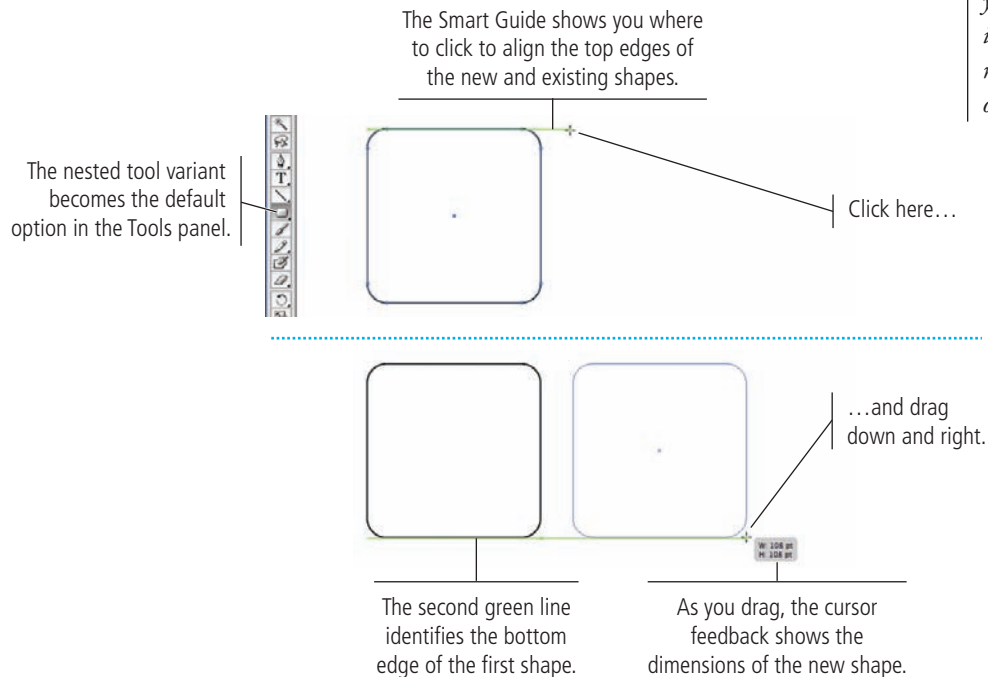

Note:

Cursor feedback and Smart Guides provide precise control over what you're creating — as individual objects and in relation to other objects on the artboard.

10. While still holding down the mouse button, press the Shift key. When the cursor feedback shows both Width and Height values of 108 pt, release the mouse button to create the second shape.

Pressing Shift **constrains** the shape to equal height and width. Although you can accomplish the same result by carefully monitoring the cursor feedback, pressing the Shift key makes the process faster and easier.

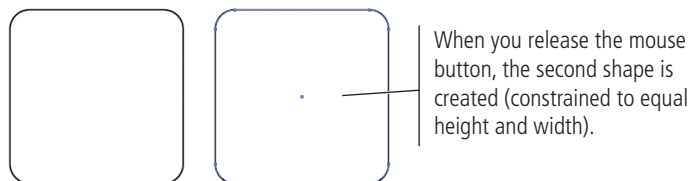

Note:

If you do something wrong, or aren't happy with your results, press Command/Control-Z to undo the last action you took.

Selection Basics

Most Illustrator objects (including shapes like rounded-corner rectangles) contain two basic building blocks: anchor points and paths. In fact, these building blocks are the heart of vector graphics. Fortunately, you don't really need to worry about the geometric specifics of vectors because Illustrator manages them for you. But you do need to understand the basic concept of how Illustrator works with anchor points and paths. You should also understand how to access those building blocks so you can do more than create basic shapes.

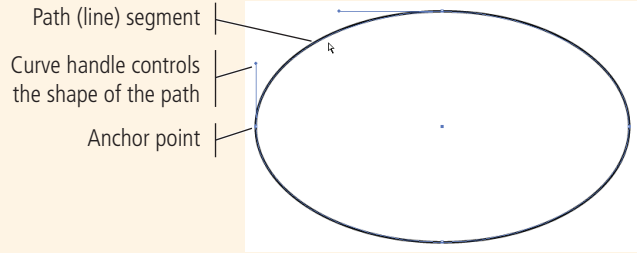

When you select an object with the **Selection tool** (the solid arrow), you can see the bounding box that identifies the outermost dimensions of the shape. Around the edges of the bounding box you see the bounding box handles, which you can use to resize the shape. (Press Command/Control-Shift-B to show or hide the bounding box of selected objects.)

When you select an object with the **Direct Selection tool** (the hollow arrow), you can see the anchor points and paths that make up the selected object rather than the object's bounding box. As you work with Illustrator, keep this distinction in mind: use the Selection tool to select an entire object; use the Direct Selection tool to edit the points and paths of an object.

Selection tool

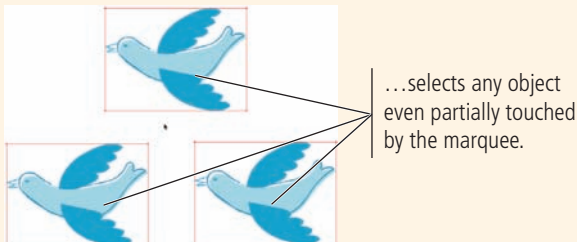
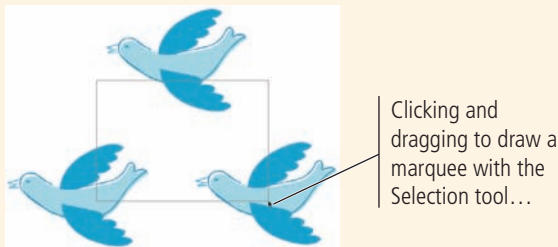
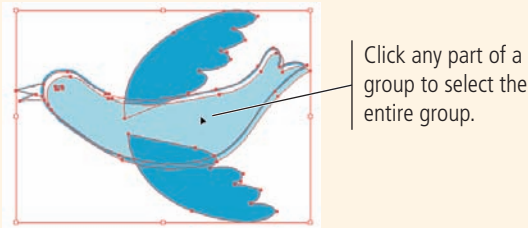
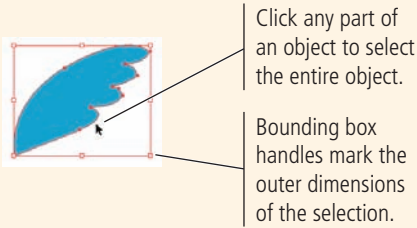

Direct Selection tool

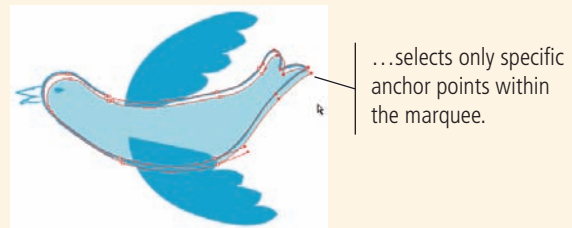
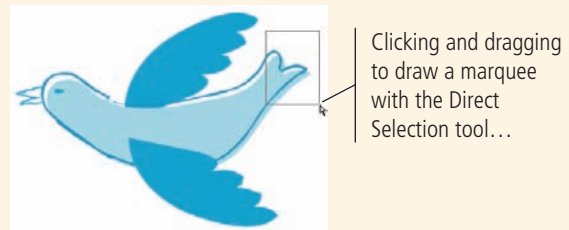
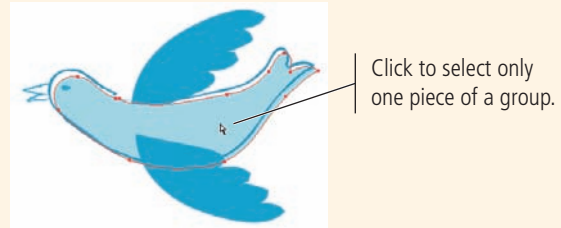
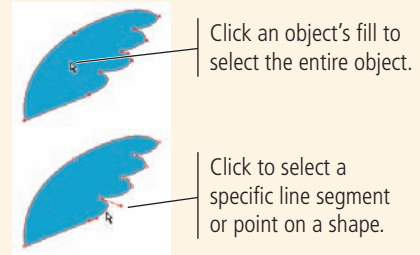

11. Move the cursor to the right until a green line connects to the center of the second shape. Click, press Option/Alt-Shift, and drag down and right until a green line connects to the bottom of the second shape.

Pressing the Option/Alt key allows you to create a shape from the center out; in other words, the point where you click will be the exact center of the resulting shape.

Pressing Shift as well constrains the new shape to equal height and width, growing out from the center point where you first clicked.

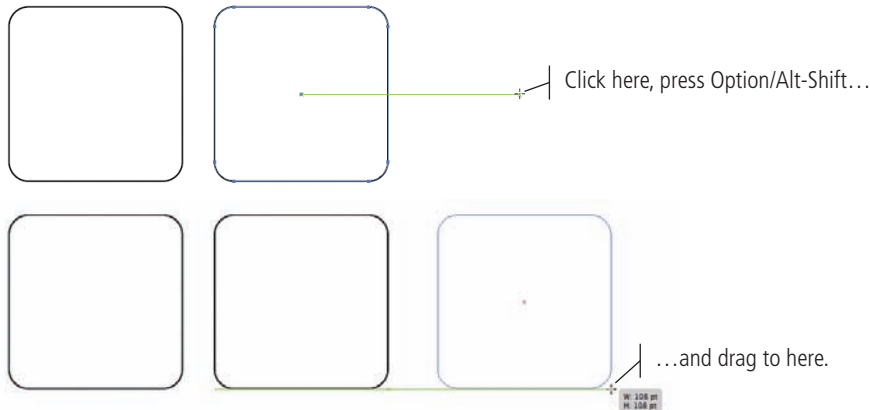

Note:

Don't worry about the spaces between the objects. You'll adjust the object spacing in a later exercise.

12. When the cursor feedback shows both Width and Height values of 108 pt, release the mouse button.

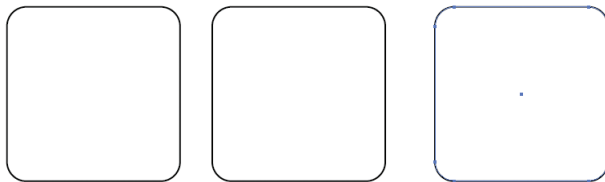

13. Save the file and continue to the next exercise.

CONTROL FILL AND STROKE ATTRIBUTES

At the beginning of the previous exercise, you clicked the Default Fill and Stroke button in the Tools panel to apply a white fill and 1-pt black stroke to the objects you created. Obviously, most artwork requires more than these basic attributes. Illustrator gives you almost unlimited control over the fill and stroke attributes of objects on the artboard.

As you complete the projects in this book, you will learn about styles, patterns, gradients, effects, and other attributes that can take an illustration from flat to fabulous. In this exercise, you learn about a number of options for changing the basic fill, stroke, and color attributes for objects on the page.

1. With **icons.ai** open, choose the Selection tool at the top of the Tools panel. Click the left rectangle on the artboard to select it.

The Selection tool is used to select entire objects.

2. Open the Swatches panel.

The Swatches panel includes a number of predefined and saved colors, which you can use to change the color of the fill and stroke of an object. You can also save custom swatches, which you will learn about in Project 2.

Note:

Remember, panels can always be accessed in the Window menu.

3. Near the bottom of the Tools panel, click the Stroke icon to bring it to the front of the stack.

The Fill and Stroke icons in the Tools panel are used to change the color of the related attributes. Clicking one of these buttons brings it to the front of the stack (makes it active) so you can change the color of that attribute.

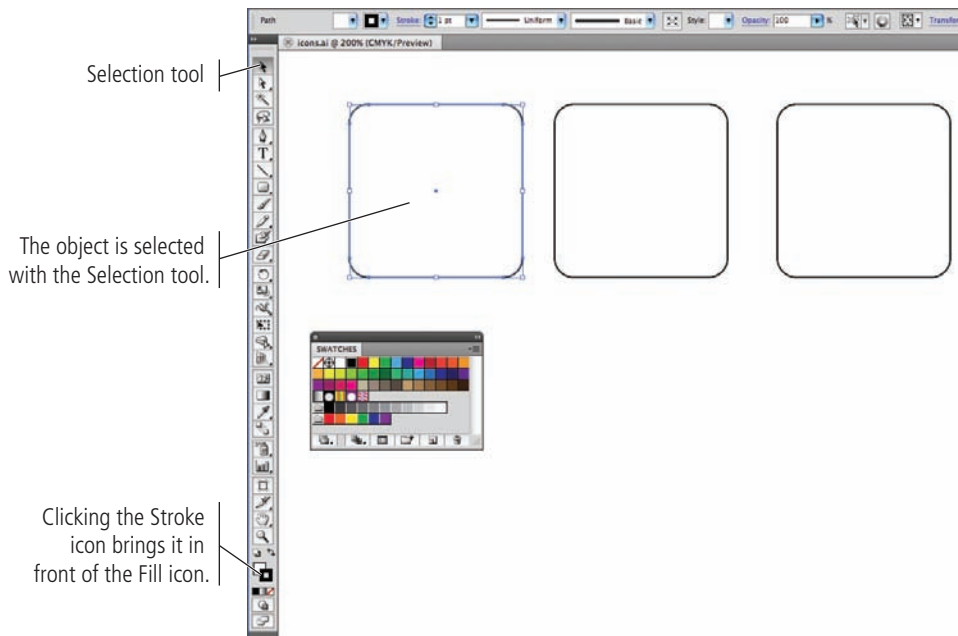

Note:

It is very easy to forget to check which icon (fill or stroke) is on top of the stack. If you forget and accidentally change the color of the wrong attribute, simply undo the change (press Command/Control-Z) and bring the correct attribute to the front before changing colors.

4. In the Swatches panel, click the gold swatch at the beginning of the second row.

Because the Stroke icon is active in the Tools panel, the color of the selected object's stroke (border) changes to gold.

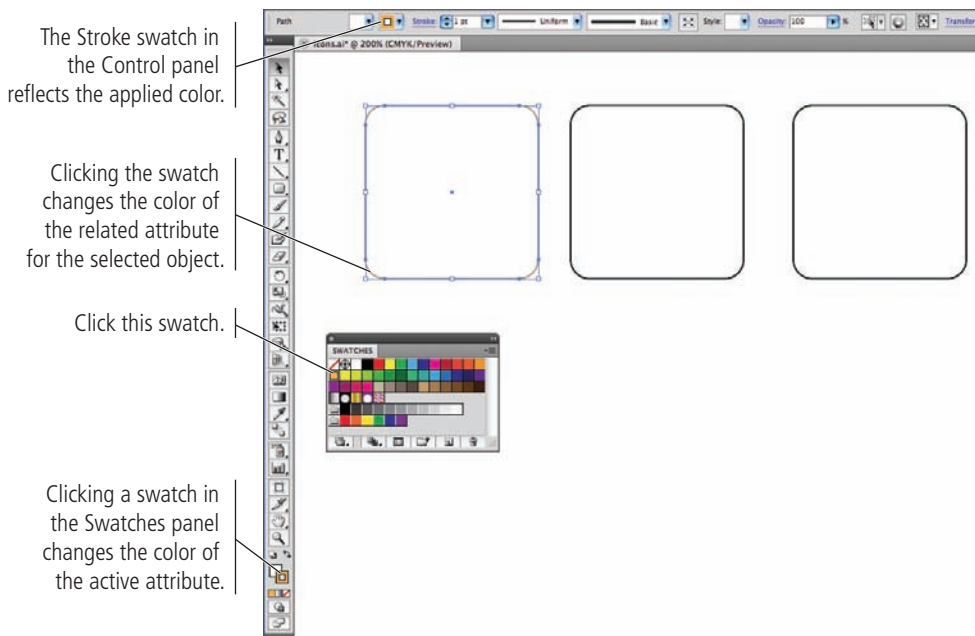

5. In the Tools panel, click the Fill icon to bring it to the front of the stack.

6. In the Swatches panel, click the black swatch in the first row.

Because the Fill icon is active in the Tools panel, clicking the black color swatch changes the fill color of the selected object.

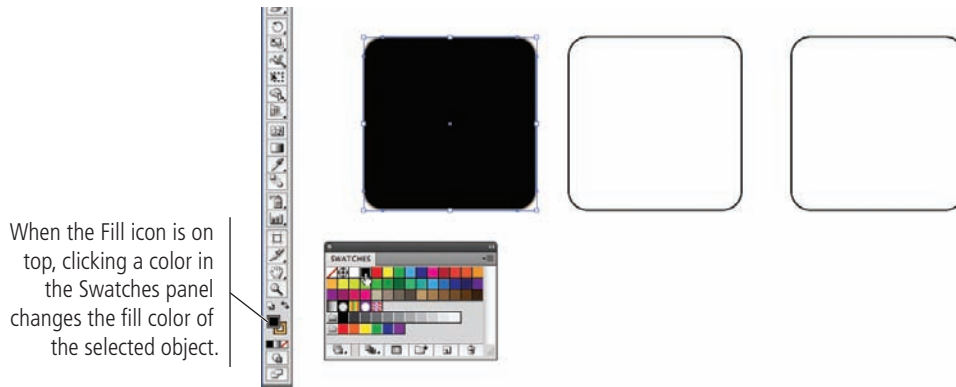

Transforming Objects with the Bounding Box

ILLUSTRATOR FOUNDATIONS

Bounding box handles make it easy to transform an object on the artboard. You can resize an object by dragging any handle, and even rotate an object by placing the cursor directly outside a corner handle. (If Smart Guides are active, cursor feedback helps if you want to make specific transformations, or you can work freestyle and drag handles until you're satisfied with the results.)

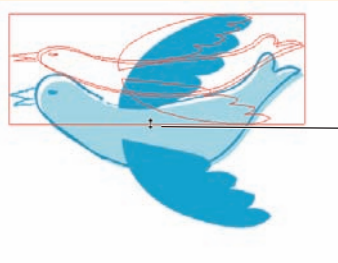

Drag a side handle to change the height or width of an object.

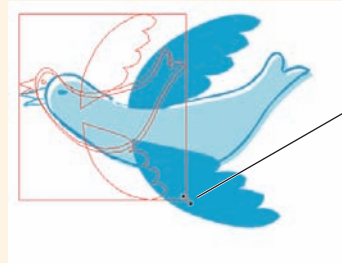

Drag a corner handle to change both the height and shape of an object at once.

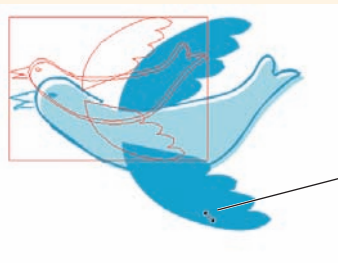

Shift-drag to maintain an object's original height-to-width aspect ratio.

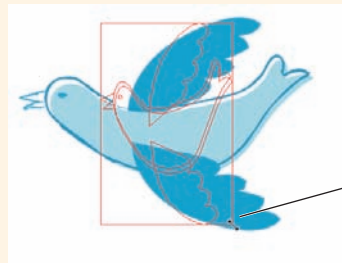

Option/Alt-drag a corner handle to change the size around the object's center point.



Click directly outside an object's corner handle to rotate the object.

Free Transform Options

The Free Transform tool  allows you to change the shape of selected objects by dragging the bounding box handles. Depending on where you click and whether you press a modifier key, you can use this tool to stretch, shrink, rotate, distort, or skew a selection.

Click a center handle to stretch or shrink the selection in one direction.

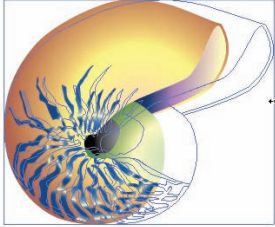

Click a corner handle to stretch or shrink the selection horizontally and vertically at the same time.

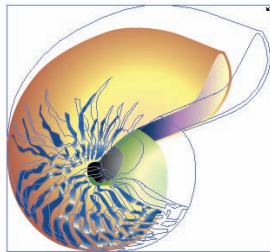

Click slightly outside a corner handle to rotate the selection.

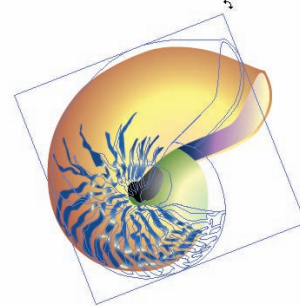

Click a center handle, then press Command/Control to skew the selection.

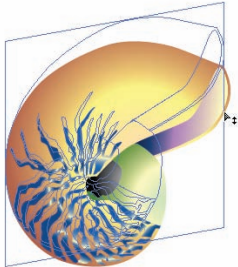

Click a corner handle, then press Command/Control to distort the selection.

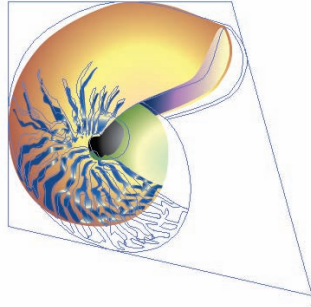

Click a corner handle, then press Command-Option-Shift/Control-Alt-Shift to alter the perspective of the selection.

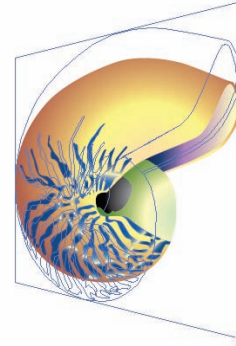

Press Option/Alt while making any free transformation to apply it equally on both sides of the selection center.

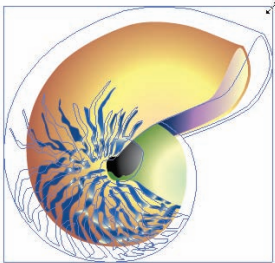

Press Shift and drag a handle to constrain the related transformation. For example, press Shift while dragging a corner handle to scale the selection at the same proportional height and width (below left) rather than scaling disproportionately (below right).

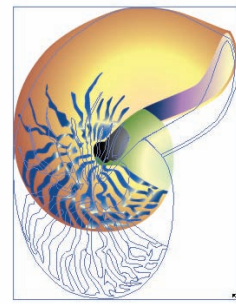
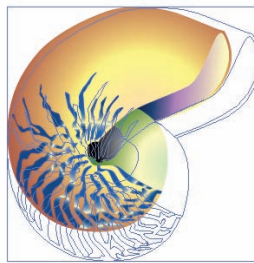

7. Open the Stroke panel. With the rounded rectangle still selected on the artboard, change the Stroke Weight to 3 pt.

The Stroke icon in the Tools panel does not need to be active to change the stroke weight. The Tools panel icon relates to the stroke color only.

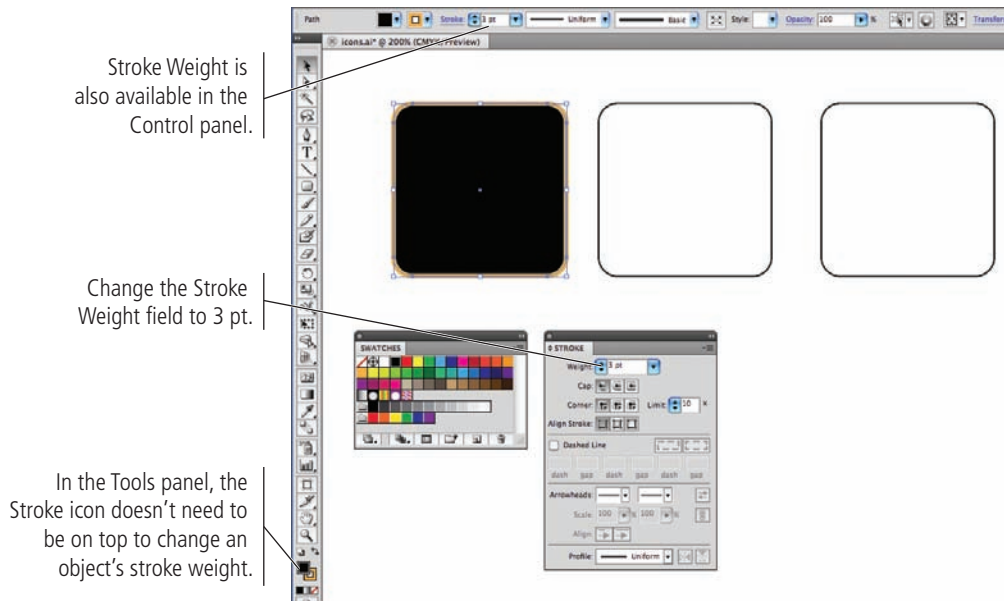

8. With the rectangle still selected, click the Swap Fill and Stroke button in the Tools panel.

This button makes it easy to reverse the fill and stroke colors of an object; the stroke weight remains unaffected when you swap the colors.

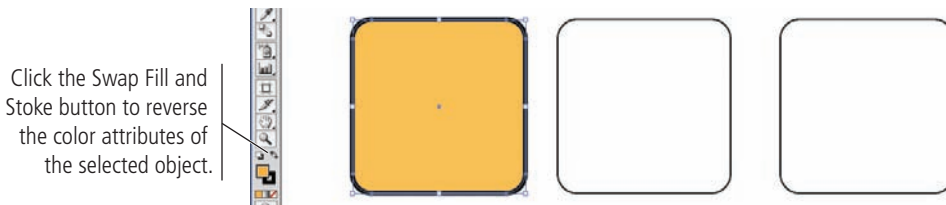

9. Using the Selection tool, click the second rectangle on the artboard.

The Fill and Stroke icons change to reflect the colors of the selected objects.

10. Click the Fill color swatch in the Control panel. Choose the gold swatch in the second row to change the fill color for the selected object.

When an object is selected with the Selection tool, the Control panel provides quick access to the stroke and fill attributes of the selected object.

Clicking the Fill color swatch opens an attached Swatches panel so you can change the fill for the selected object without opening the separate Swatches panel.

Note:
When you use the Control panel options, you don't need to worry about which icon is active in the Tools panel.

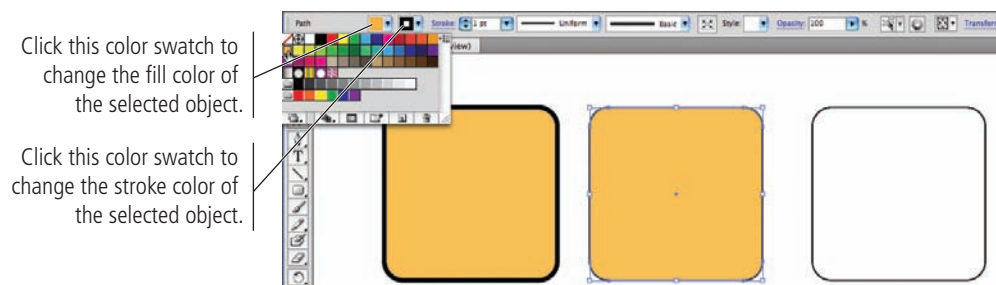

11. In the Control panel, change the Stroke Weight value to 3 pt.

Again, the Control panel options allow you to change the attribute value without opening the Stroke panel. The Control panel can be a significant time-saver for common operations such as changing stroke and fill attributes.

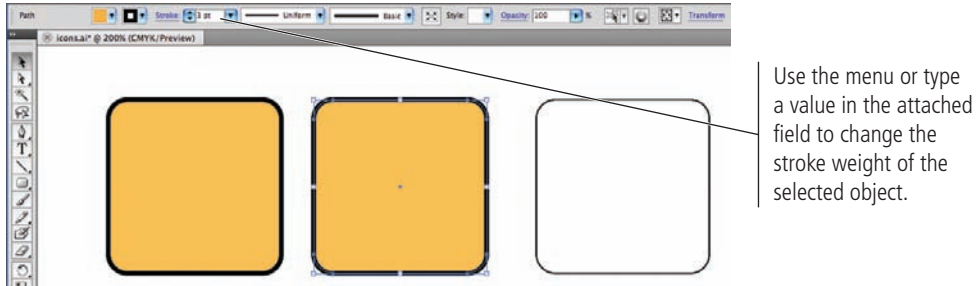

12. Using the Selection tool, click the third rectangle on the artboard.

Again, the Fill and Stroke icons in the Tools panel change to reflect the colors of the selected object.

13. Select the Eyedropper tool in the Tools panel, and then click the first or second rectangle on the artboard.

The Eyedropper tool copies fill and stroke attributes from one object (the one you click) to another (the one you first selected).

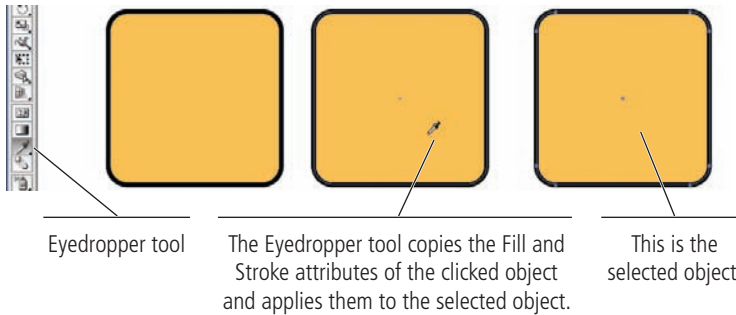

14. Press Command/Control and click anywhere on the artboard away from the three rectangles.

Pressing Command/Control temporarily switches to the Selection tool. By clicking on the empty artboard area, you can quickly deselect the selected object(s). When you release the Command/Control key, the tool reverts to the one you last used.

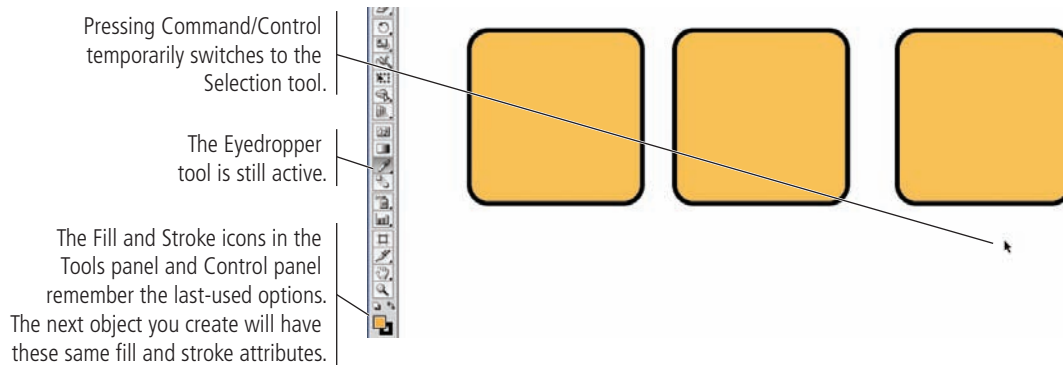

15. Choose the Rounded Rectangle tool in the Tools panel.

16. To the right of the third shape on the artboard, use any method you learned in the previous exercise to draw a fourth rounded rectangle that is 108 pt square.

The new rectangle has the same heavy black stroke and gold fill as the others.

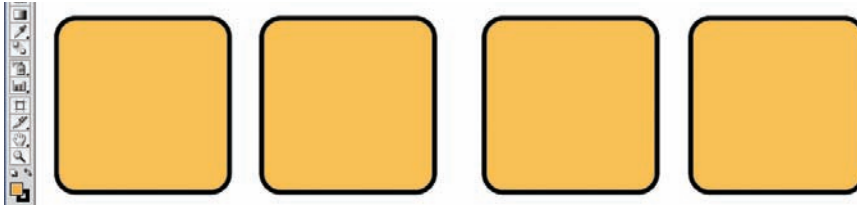

17. Save the file (File>Save or Command/Control-S) and continue to the next exercise.

CONTROL OBJECT POSITIONING

The ability to move objects around on the artboard is one of the advantages of digital drawing. On paper, you have to manually erase items and then redraw them in their new locations. Illustrator offers a number of tools that make it easy to move existing objects around the artboard, either as isolated objects or in relation to other elements on the page. In this exercise, you learn several techniques for moving objects around on the artboard.

1. With `icons.ai` open, change your zoom percentage so you can see the entire top of the artboard.
2. Choose the Selection tool from the top of the Tools panel. Click the left rectangle on the artboard to select it.
3. Choose View>Rulers>Show Rulers to show the rulers at the top and left edges of the document window.

Because you created this file using points as the default unit of measurement, the rulers — and fields in dialog boxes and panels — show measurements in points.



4. Control/right-click the top ruler and choose Inches from the contextual menu.

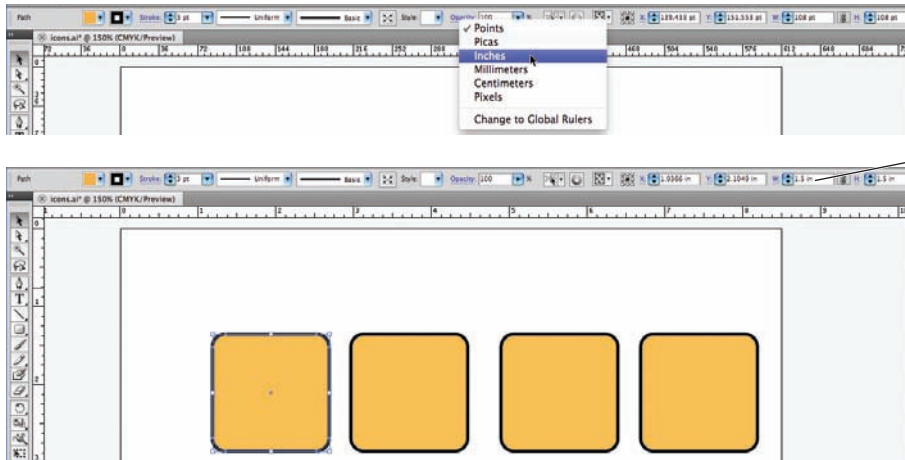

By changing the rulers to inches, measurements in the Control panel and other areas now appear in terms you are probably more familiar with.

Note:

The Change to Global Rulers option is only relevant when you work with multiple artboards. You will explore this in Projects 3 and 5.

5. With the left rectangle selected, look at the right side of the Control panel.

The reference points correspond to the bounding box handles of the selected object. The selected square in this icon identifies which point of the object is being measured.



If you don't see the X, Y, W, and H fields in the Control panel, you must click the Transform hot-text link to open the pop-up Transform panel, where you can make changes to the object's position, size, angle, or skew. If you use the panel to resize an object, you can constrain the object's height-to-width aspect ratio by clicking the chain icon. (The same options are available in the Control panel between the W and H fields.)

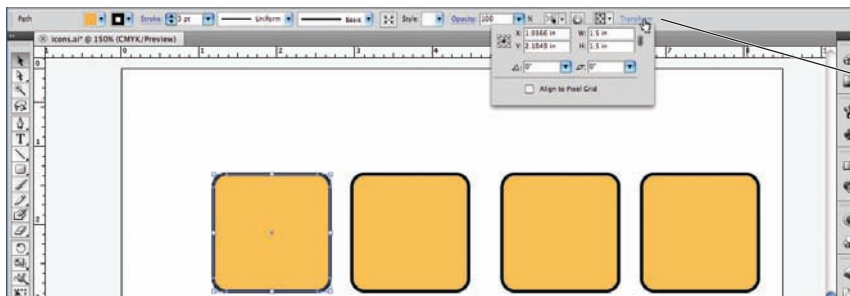

If you have a small monitor (or have reduced the Application frame width), the X, Y, W, and H options are replaced by a hot-text link that opens the Transform panel.

In Illustrator, the default **zero point** (the source of measurements) is the top-left corner of the artboard; the X and Y positions of an object are measured relative to that location. (The X axis is the horizontal value and the Y axis is the vertical value.)

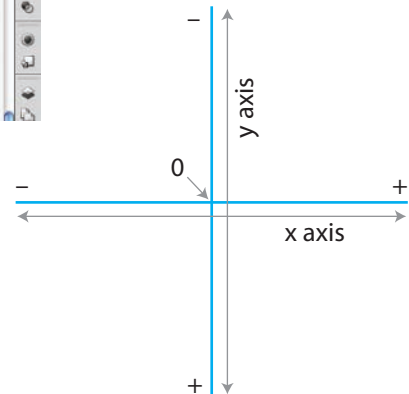

Keep these ideas in mind when you move something in an Illustrator file:

- Moving something up requires subtracting from the Y value.
- Moving something down requires adding to the Y value.
- Moving something left requires subtracting from the X value.
- Moving something right requires adding to the X value.

You can change the zero point by clicking where the horizontal and vertical rulers meet and dragging to a new position.



Note:

The default zero point in Illustrator CS5 is the top-left corner of the artboard. This is a significant change if you have used previous versions of Illustrator.

6. Click the top-left reference point (if it's not already selected).

The X and Y fields now show the exact position of the top-left bounding box handle for the selected object.

7. Highlight the X field in the Control panel and type **.5**. Press Return/Enter to apply the change.

You don't need to type the measurement unit (""), or the preceding "0". Because the rulers are showing inches, Illustrator automatically applies inches as the unit of value.

Note:

As with dialog boxes, you can enter values in a unit of measurement other than the default, as long as you remember to type the unit abbreviation.

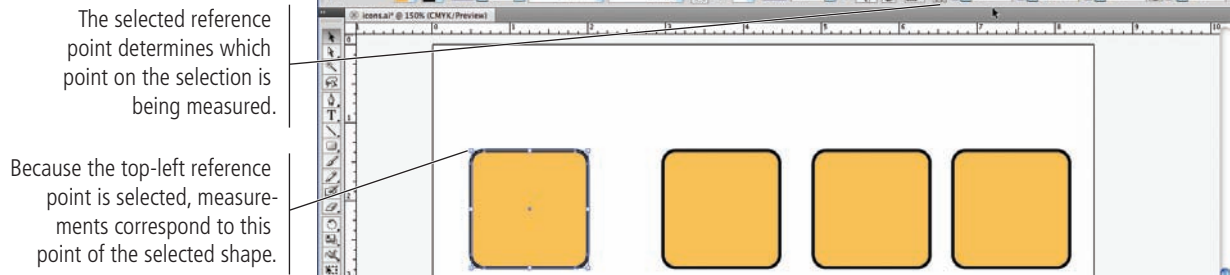

8. Highlight the Y field and type **.5**, then press Return/Enter to apply the change.

The top-left handle of the selected object is now 1/2" from the top and left edges. The numbers you typed correspond to the measurements you see on the rulers.

The rulers show that the selected point of the object is at X: 0.5", Y: 0.5".

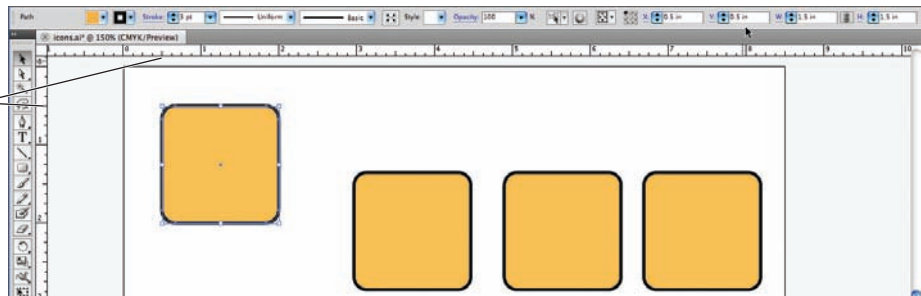

9. Using the Selection tool, click the second rectangle on the artboard and drag until a green line appears, connecting the center points of the first and second shapes.

As you drag the cursor, feedback shows the relative position of the object. In other words, you can see the change (difference) in the object's position, both horizontally (X) and vertically (Y) — hence the “dX” and “dY” values.

In addition to providing cursor feedback, Smart Guides can be very useful for aligning objects on the artboard. As you drag, Illustrator identifies and highlights relative alignment points as you drag.

Note:

Remember, moving left decreases the X value and moving up decreases the Y value.

The Smart Guide makes it easy to snap the center of one object to the center of another object.

The dX and dY values show the changes to the object's X and Y values.

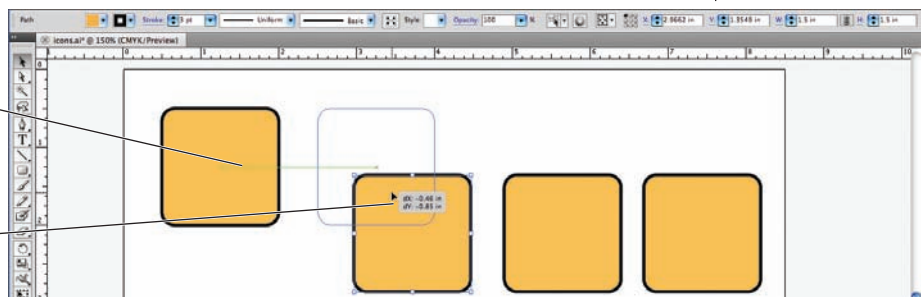

10. Release the mouse button while the center Smart Guide is visible.

If you don't see the alignment guides as you drag, make sure that option is checked in the Smart Guides preferences.

11. Click the fourth shape on the page. In the Control panel, select the top-right reference point, type 8 in the X field, and type .5 in the Y field.

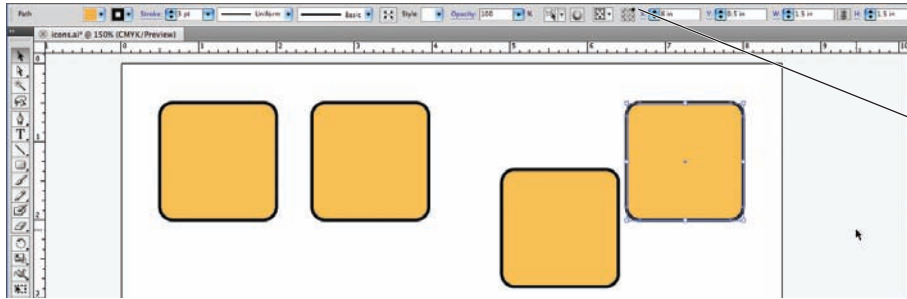

The top-right reference point means the X and Y values refer to the top-right corner of the selected shape.

Because you changed the reference point, you defined the X/Y position for the top-right bounding box handle of the fourth rectangle.

12. Save the file and continue to the next exercise.

ALIGN AND DISTRIBUTE OBJECTS

In addition to dragging objects around the artboard, the Illustrator Align panel makes it very easy to align and distribute selected objects relative to one another, to a specific key object in the file, or to the overall artboard. In this exercise, you learn how to use the Align panel to align shapes.

1. With `icons.ai` open, use the Selection tool to drag a marquee that touches some part of all four objects on the artboard.

The Selection tool selects objects, so the selection marquee only needs to touch the objects you want to select. The marquee doesn't need to surround the objects entirely.

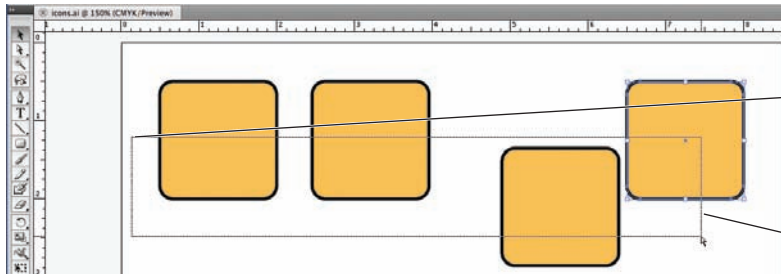

We started the marquee here because clicking the top-left shape would have resulted in dragging that shape instead of creating a selection marquee.

Selection marquee

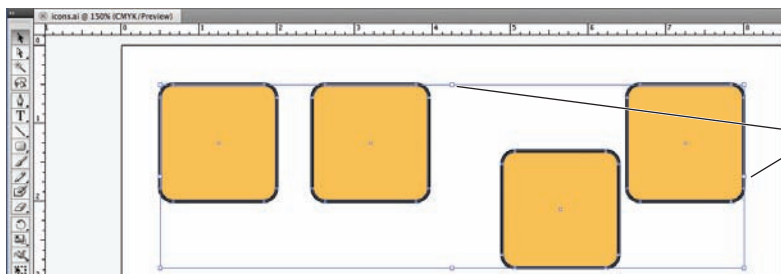

The bounding box shows the outer edges of the entire selection (the four shapes collectively).

2. Open the Align panel (Window>Align) and click the Vertical Align Top button.

By default, alignment and distribution functions occur relative to the selected objects. In other words, when you click the Vertical Align Top button, Illustrator determines the topmost edge of the selected objects, and then moves the top edges of all other selected objects to that position.

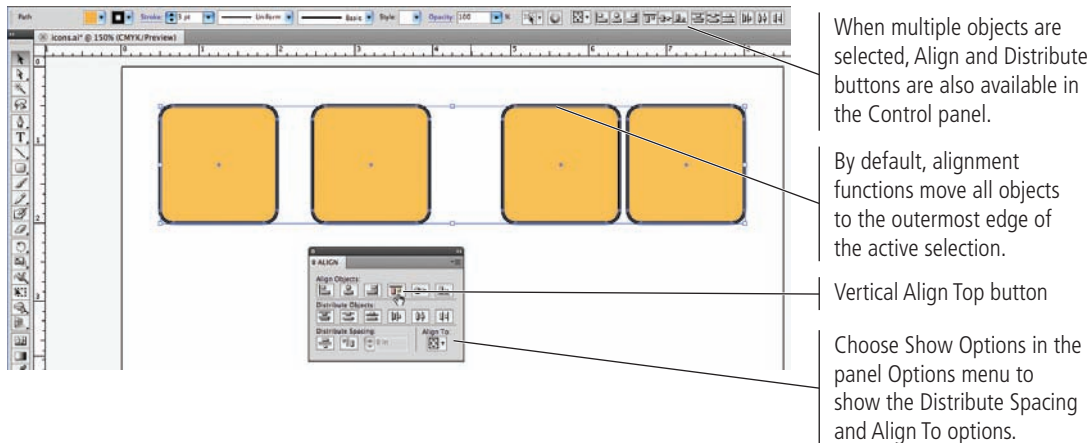

3. With all four objects selected, click the Horizontal Distribute Center button.

By default, the distribution functions create equal distance between the selected point of the selected objects. In this case, Illustrator distributed the center points along the horizontal axis. Illustrator determined the center-point positions of the outermost selected objects, and then moved the middle two objects to create equal distance between the center points of all four selected objects; the positions of the two outer objects remained unchanged.

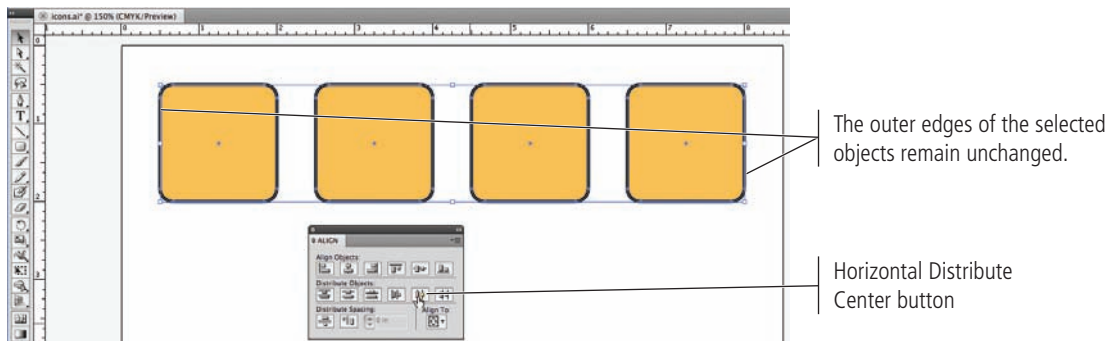

4. With all four objects selected, choose Object>Group.

When you group multiple objects, the group is essentially treated as a single object. A single bounding box surrounds all objects within the group.

5. Click inside any of the grouped objects, press the Option/Alt key, and drag down.

Note:

Press Command/Control-G to group selected objects. Press Command/Control-Shift-G to ungroup grouped objects.

6. Use the Smart Guides and cursor feedback to drag exactly vertical (the dX value should be 0). When the dY value in the cursor feedback is 2 in, release the mouse button.

Pressing Option/Alt while you drag makes a copy of the original selection. This technique, called **cloning**, can save significant amounts of time when you build illustrations that contain numerous repetitive elements.

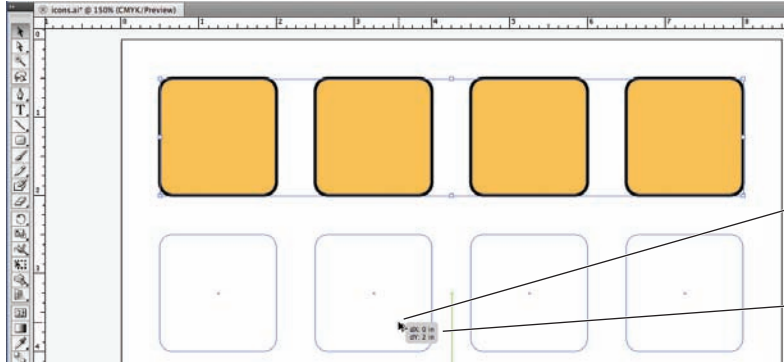

The cursor icon shows that you are cloning instead of simply dragging.

Cursor feedback makes it easy to move something to precise locations.

Note:

There is almost always more than one way to accomplish a specific task. The Align panel is useful for certain functions (especially distribution), but Smart Guides make object-to-object alignment very easy.

7. With the second group of rectangles selected, choose Object>Transform>Transform Again.

This command repeats the last-used transformation. In this case, the last transformation was the cloning movement, so it creates the third row of rectangles.

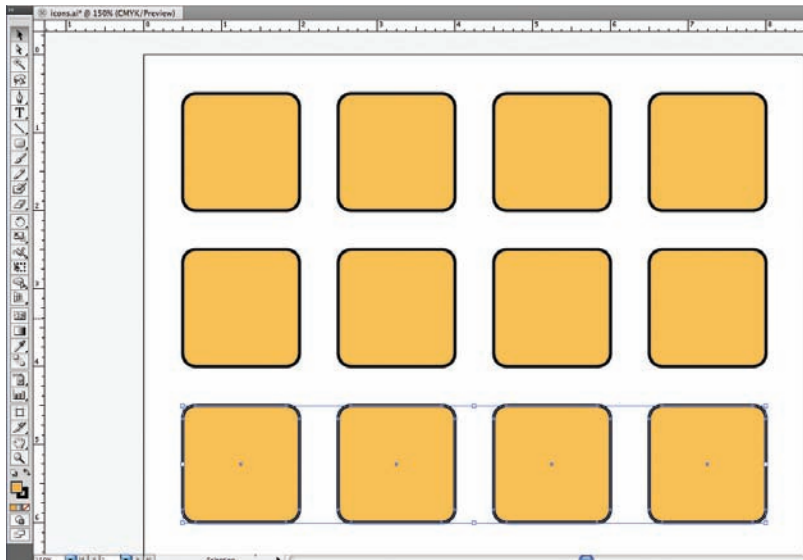
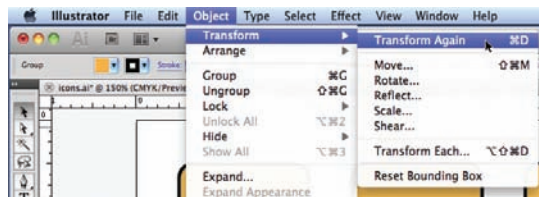

Note:

Press Command/Control-D to repeat the last-used transformation.

8. Click anywhere outside the rectangle shapes to deselect all objects and groups.
9. Save the file and continue to the next exercise.

EDIT INDIVIDUAL GROUPED ELEMENTS

The client in this project requested only ten icons, so you don't need two of the rectangles in the third row. As you know, the Selection tool selects entire objects on the page. You also know that grouped objects are treated as a single object — which means you can't use the Selection tool to select part of a group. In this exercise, you use two techniques to work with component pieces of a group.

1. With `icons.ai` open, use the Selection tool to click the fourth rectangle in the third row.

Because the four objects are grouped, the Selection tool selects the entire group. You need to use a different method to select certain elements within the group.

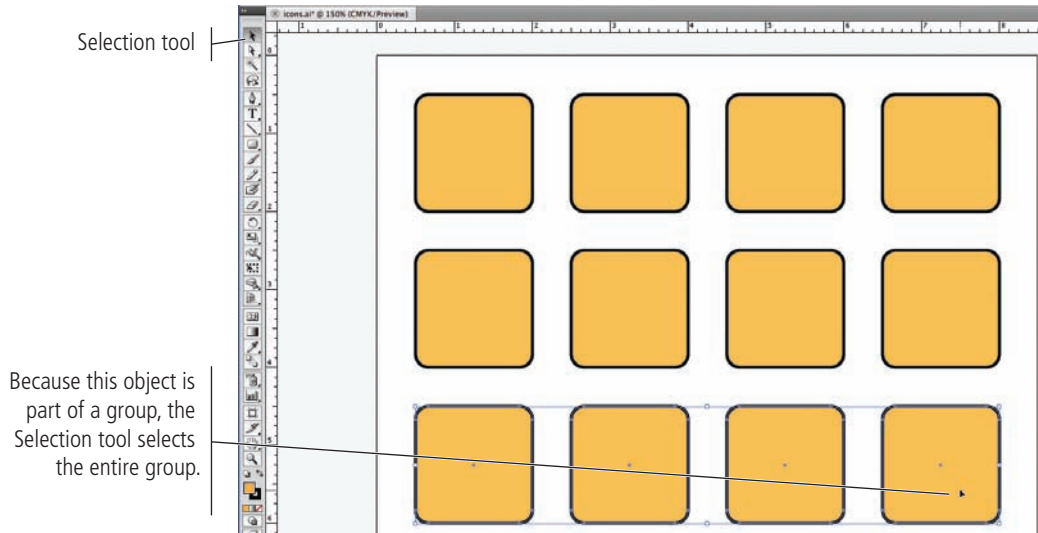

2. Click anywhere outside the rectangle shapes to deselect the group, then choose the Direct Selection tool in the Tools panel.

The Direct Selection tool selects pieces of an object — specific paths, anchor points, or individual elements in a grouped object.

3. Click the gold fill of the fourth rectangle in the third row.

Because you clicked the fill, you selected the entire object. If you had clicked along the object's stroke, you would have selected that particular segment of the shape's edge.

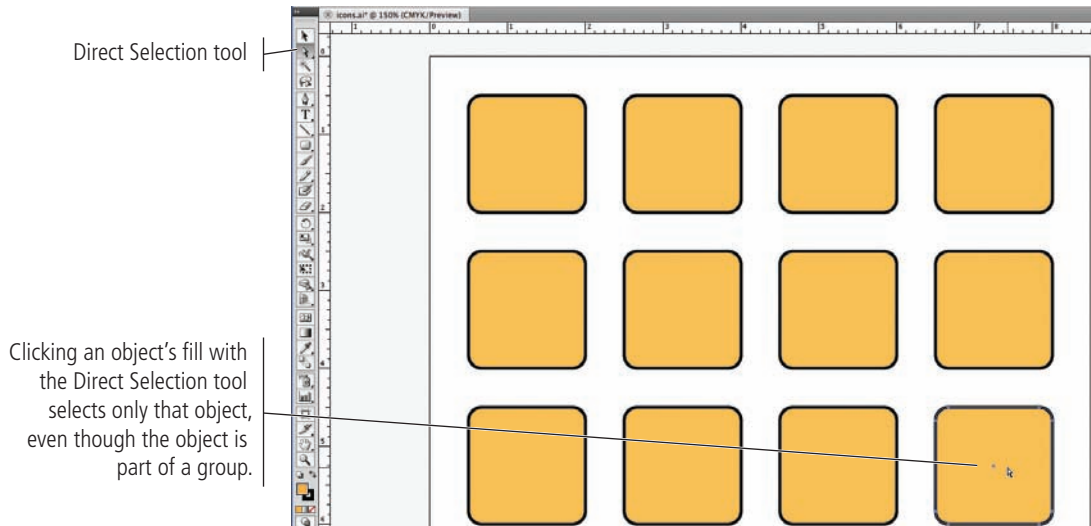

Note:

Think carefully about your ultimate goal when you group objects, especially for alignment purposes. If the objects in a group don't need to stay together, it's often a good idea to ungroup them.

4. Press Delete to remove the selected object.

Easy enough, especially because this is a very simple group of objects that don't overlap. When you start working with complex files that have multiple levels of grouping, however, it can be challenging to manipulate objects within a group using only the Direct Selection tool.

5. Choose the Selection tool in the Tools panel, and then double-click the third rectangle in the third row.

Double-clicking a group enters into Isolation mode, where only objects within the selected group are available. Basically, Isolation mode provides access to objects in the group without ungrouping the objects on the main artboard.

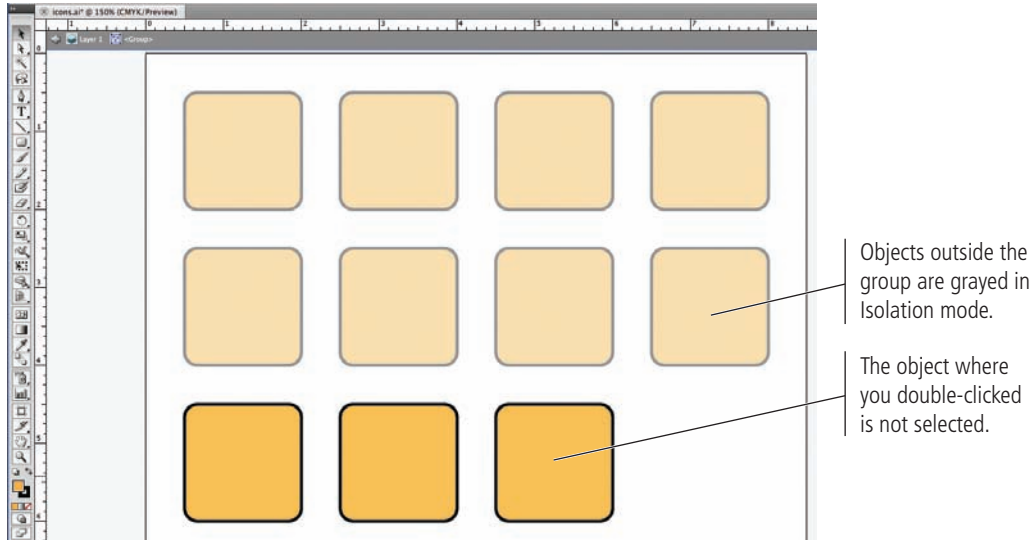

6. Using the Selection tool, click the third rectangle in the third row to select it, and then press Delete.

Because you created only a single level of grouping, you can now use the Selection tool to select individual objects.

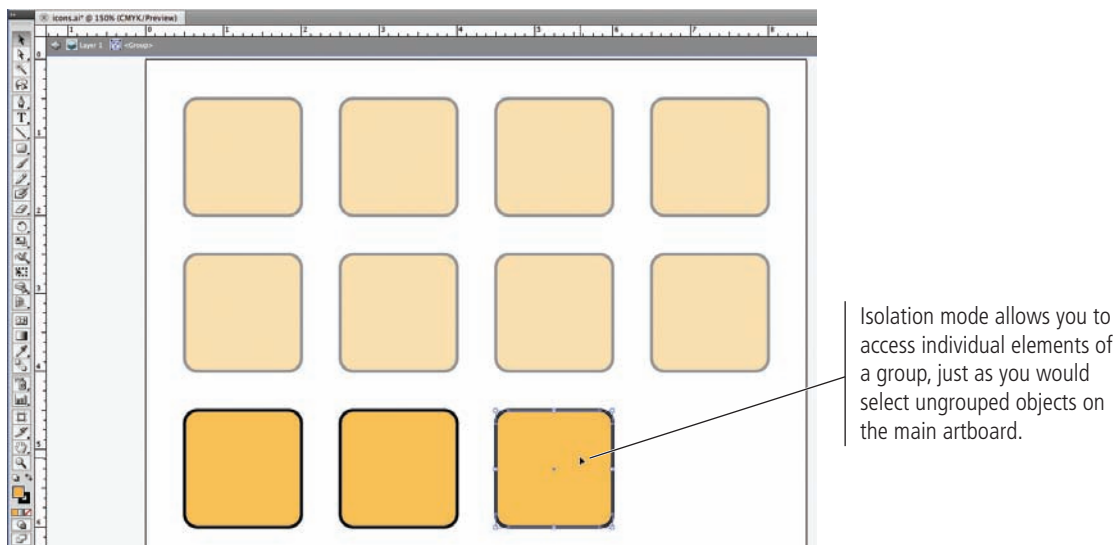

7. At the top of the document window, click the Arrow button twice to return to the main artboard.

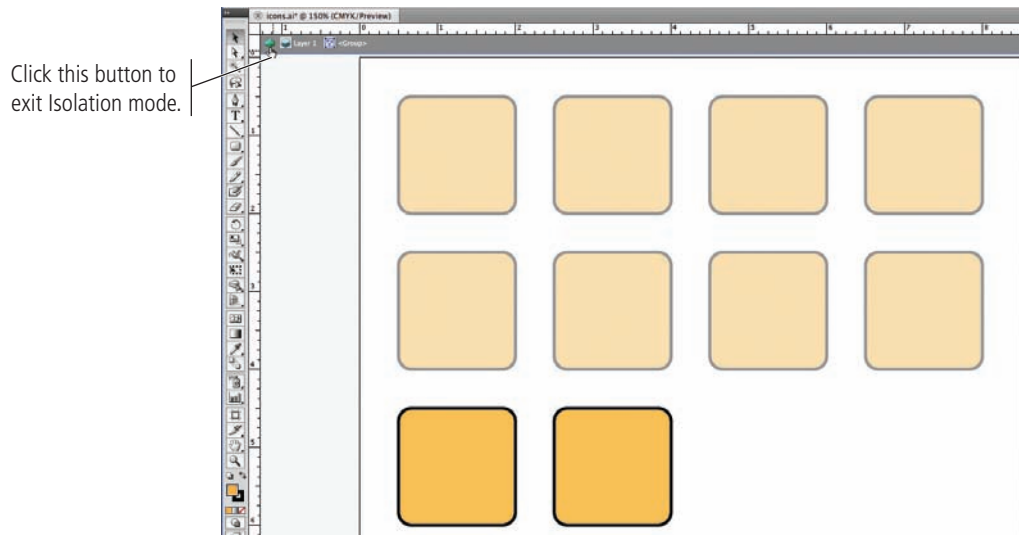

The third row, now with two rectangles, is still a single group on the main artboard.

8. Save the file and continue to the next exercise.

IMPORT TEMPLATE IMAGES

Many Illustrator projects require you to start with something that has already been captured — a sketch, photograph, or low-resolution image (which is the case in this project). Illustrator makes it easy to place existing digital files to use as templates for your new artwork. You will use this feature in this exercise.

1. With `icons.ai` open, choose `File>Place`. Navigate to your `WIP>Symbols` folder and click `cold.tif` to select that file.
2. At the bottom of the Place dialog box, make sure the Link option is unchecked.

If you check the Link option, the placed file does not become a part of the actual file where you're working; for the file to output properly, Illustrator must be able to locate the linked file in the same location (hard drive, CD, etc.) as when you placed it. If the Link option is *not* checked, the placed file is **embedded** — it becomes part of the file where it's placed; the original external file is not necessary for the artwork to output properly. We will explore the details of placed files in later projects.

3. Check the Template option.

When you place an object as a template, it's added to the file on a separate, non-printing layer that is partially grayed, making it easier to work with.

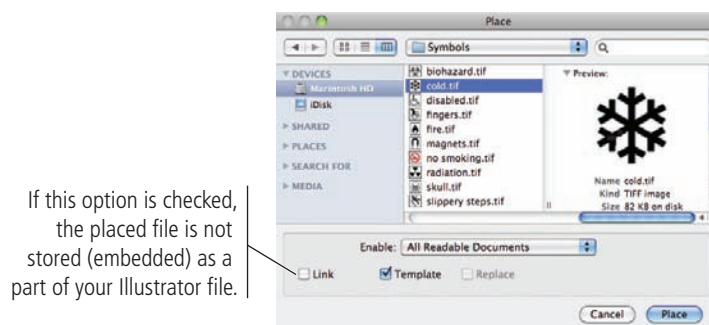

4. Click Place.

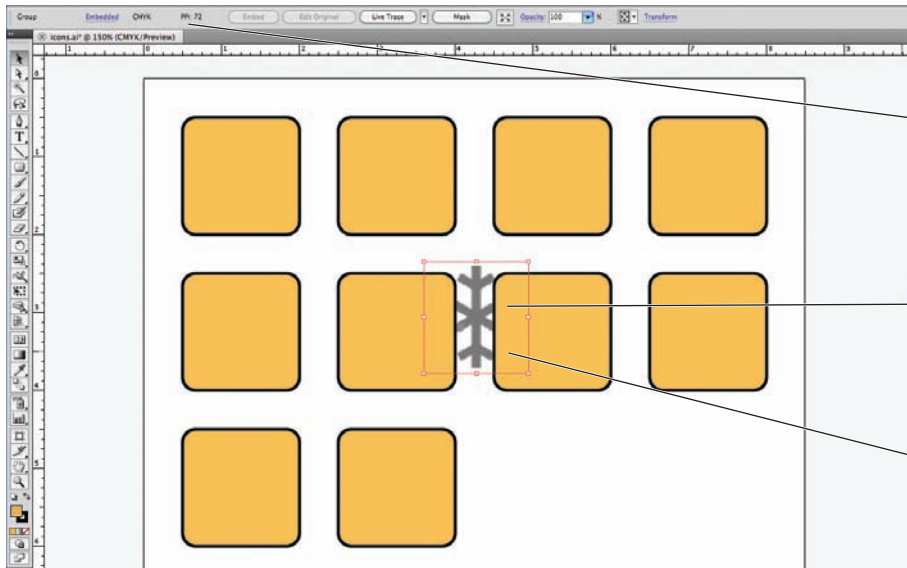

The Control panel shows information about the placed image, including the resolution and the embedded status.

The placed image is partially hidden by the background shapes. You will correct this problem in the next exercise.

Placed images are automatically located in the exact center of the document window.

5. Choose File>Place a second time. Select radiation.tif in the list, check the Template option, and click Place.

The Place dialog box remembers the last-used location, so you don't have to re-navigate to the Symbols folder. The Link option also remembers the last-used settings. The Template option, however, always defaults to off, so you have to manually check this box for each template object.

Make sure you remember to check the Template option.

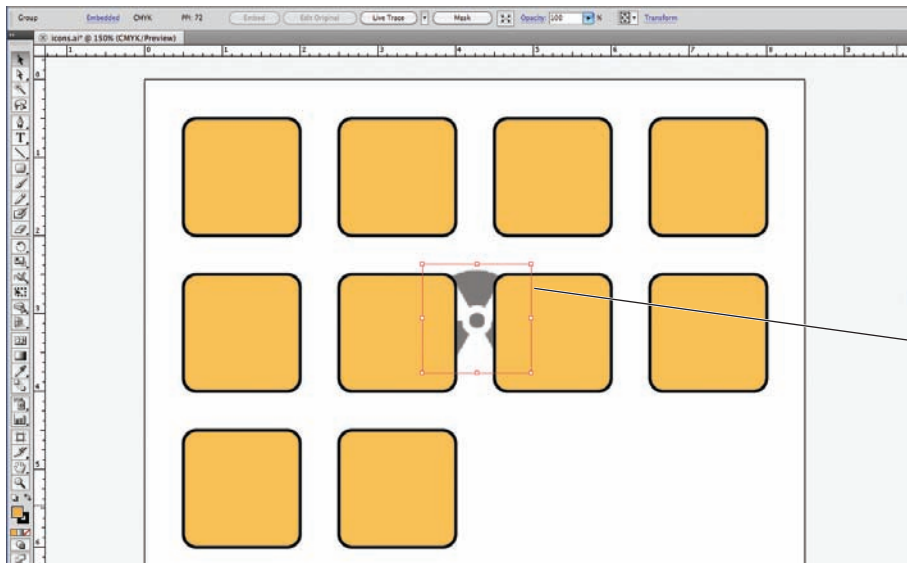
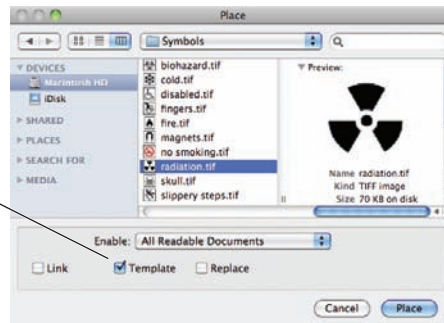

This image is also placed in the center of the document window, directly on top of the first placed image.

6. Repeat Step 5 to place `fire.tif` into your file as a template image.

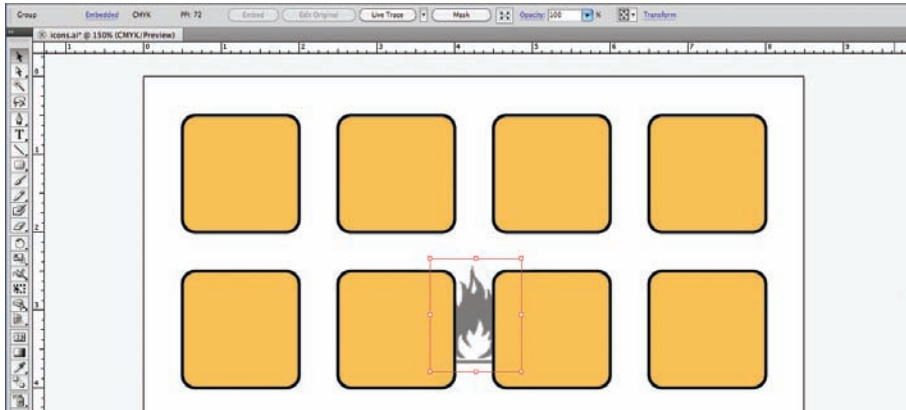

7. Save the file and continue to the next exercise.

MANAGE MULTIPLE LAYERS

When you create digital artwork in Illustrator, you almost always end up with more than one object on the artboard. In many cases, a completed file has dozens or hundreds of objects, arranged in specific order on top of one another. As files become more and more complex, it can be difficult to find and work with exactly the pieces you need. Illustrator layers are one of the most powerful tools available for solving this organizational problem.

1. In the open `icons.ai` file, open the Layers panel.

By default, all files have a single layer, named Layer 1. Your file has three additional layers — the template layers — below Layer 1. Template layers are locked by default, which means you can't select or modify objects on those layers.

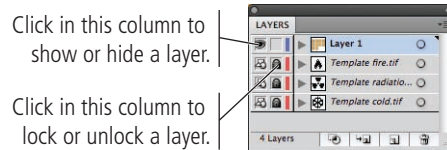

2. In the Layers panel, click the Layer 1 name and drag it below all three template layers in the stack.

The top-to-bottom position of objects or layers is called the **stacking order**. Objects and layers typically appear in the stack based on the order in which they are created — the first-created is at the bottom, the last-created is at the top, and so on in between.

Placed template objects are the exception; these layers are placed *below* the currently selected layer (i.e., lower in the stacking order). In this case, the rectangle shapes are filled with a color, which obscures the template images on the underlying layers. To see the template images, you need to move the template object layers above the layer containing the background shapes. Rather than moving three layers above Layer 1, you can save a few clicks by moving Layer 1 below all of the template layers.

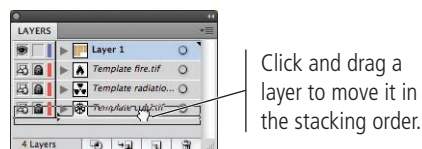

3. Using the Selection tool, click the top-left rounded rectangle to select it.

Remember, this object is grouped with the other rectangles in the same row. You need to align the placed object to only the first rectangle, which means you need to be able to select only that object.

As you saw in an earlier exercise, you can use Isolation mode to access a single element of a group. However, each rectangle shape is ultimately going to be a separate icon; you're simply creating them all in the same workspace. The best choice here is to simply ungroup the rectangles, returning them to individual objects.

4. With the top-row group selected, choose Object>Ungroup.

5. Click away from the selected objects to deselect them, and then click the top-left rectangle to select that object only.

6. In the Layers panel, click the Lock icon for the Template cold.tif layer.

Because you need to move the placed template object into the correct position, you first need to unlock the layer.

7. With the Selection tool still active, press Shift and click anywhere inside the area where the template images are placed.

Pressing Shift allows you to add objects to the current selection. The first rectangle and the image should both be selected.

8. With both objects selected, click the Align To button in the Control panel.

Note:

Press Command/Control-Shift-G to ungroup objects in a group.

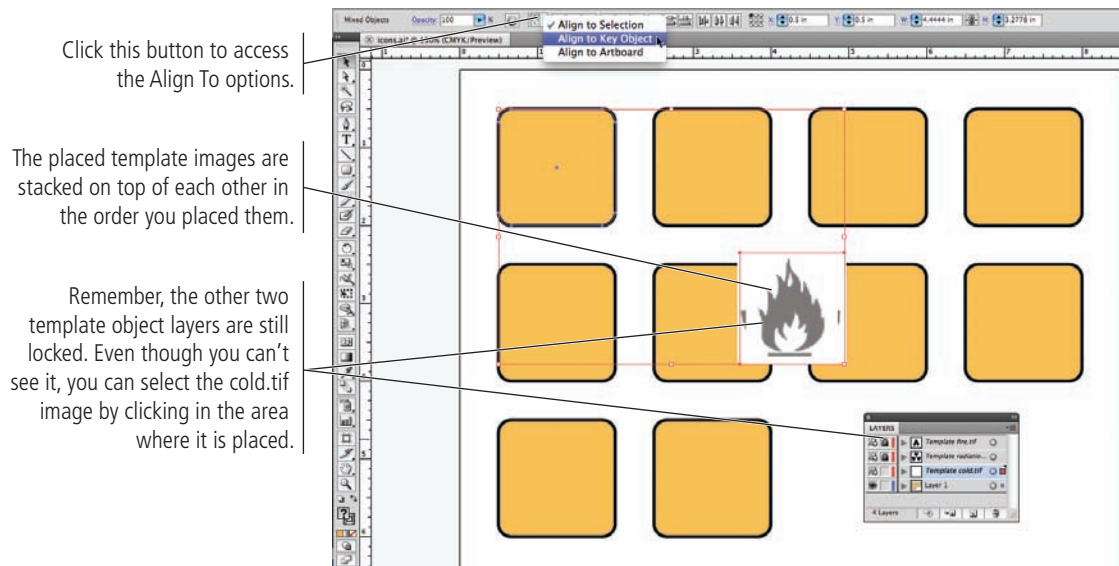

9. Choose Align to Key Object in the menu.

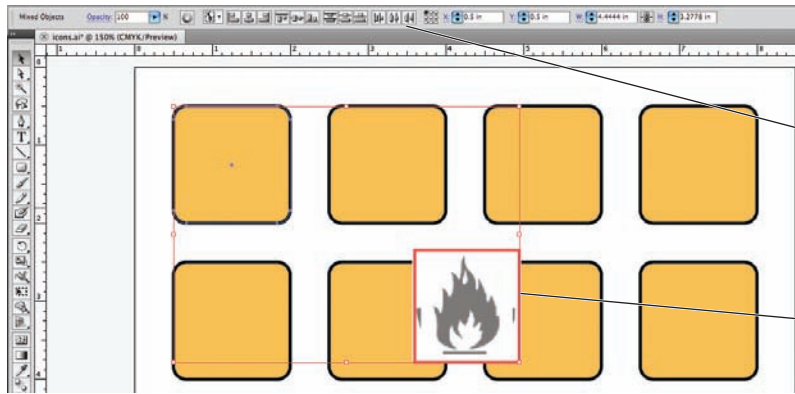

The Align and Distribute options in the Control panel are the same as the options in the Align panel.

The default key object is identified with a heavy border.

10. Click the selected rounded rectangle on the artboard.

Key Object alignment allows you to define where you want other objects to align. By selecting the key object, you're telling Illustrator which object to use as the basis for alignment.

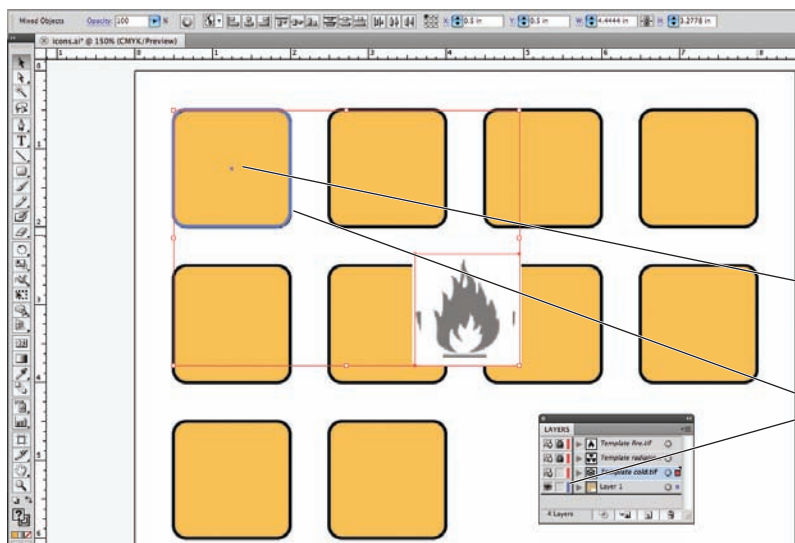

Click any object to define the key object for the alignment.

The border color matches the defined layer color.

11. Click the Horizontal Align Center and Vertical Align Center buttons in the Control panel.

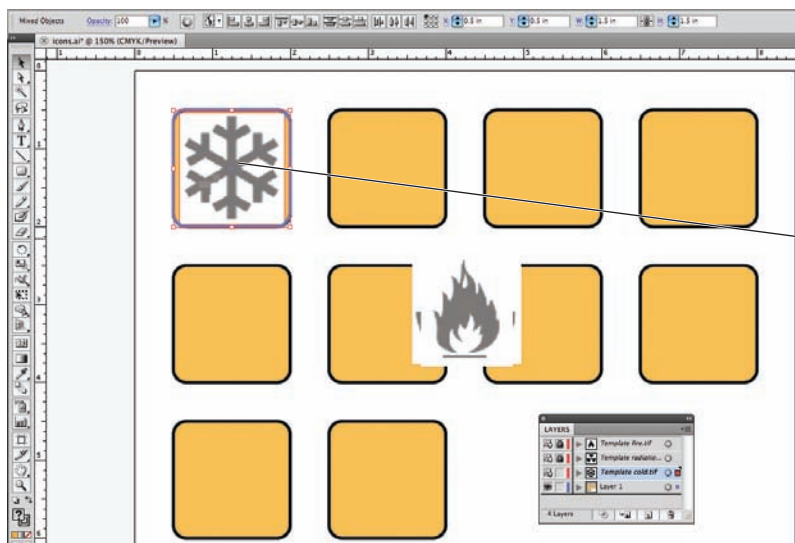

Because you selected the rounded rectangle as the key object, the placed template image moves to the horizontal and vertical center of the rounded rectangle; the rectangle — the key object — remains in the same place.

12. In the Layers panel, click the empty space to the left of the Template cold.tif layer to relock that layer.

Now that the template object is in place, it's a good idea to lock it again so you don't accidentally move the object.

13. Double-click the name of the Template cold.tif layer.

Double-clicking a layer name opens the Layer Options dialog box for that layer, where you can change a number of attributes for the selected layer.

14. Change the Dim Images To field to 30, and then click OK to close the Layer Options dialog box.

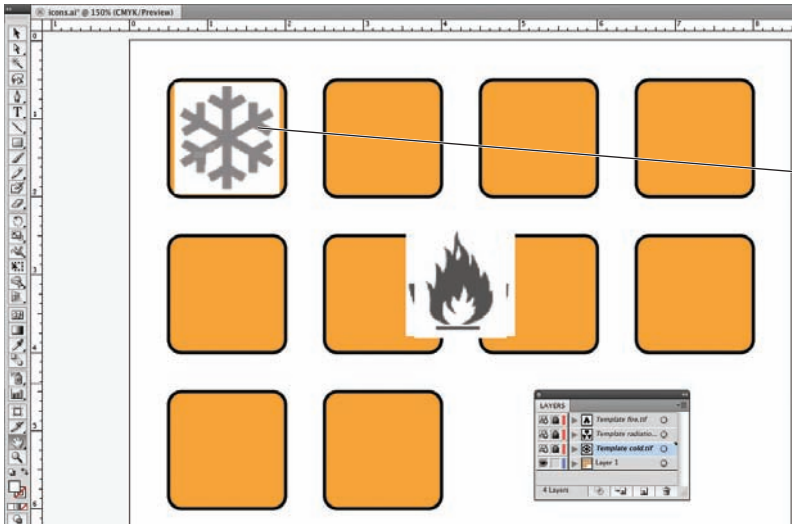
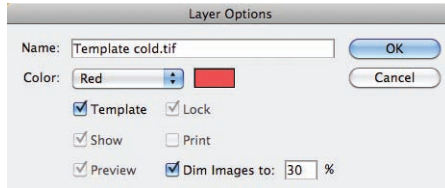

15. Repeat Steps 6–14 to position the other two template images in the first-row rectangles (as shown in the following image).

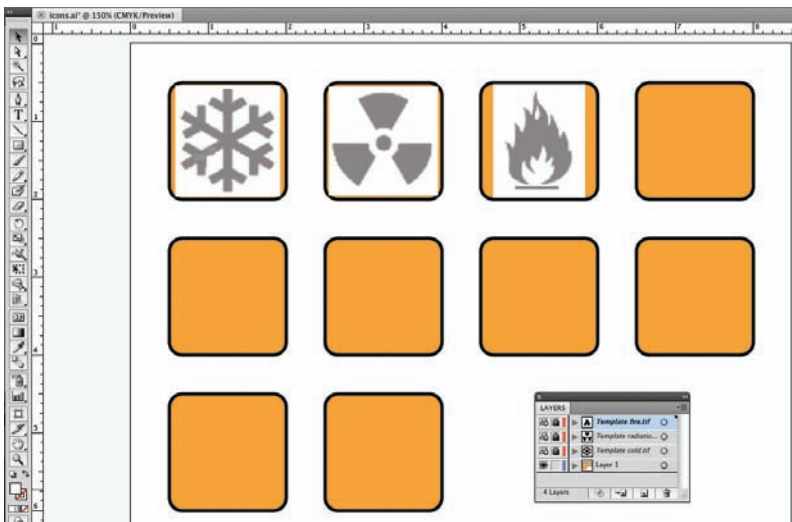

16. In the Layers panel, double-click the Layer 1 name to open the Layer Options dialog box. Change the Layer Name field to **Background Shapes** and click OK.

Whenever you have more than one working layer, it's a good idea to use names that tell you what is on each layer. Doing so prevents confusion later when you or someone else needs to change a particular item.

17. In the Layers panel, click the empty space immediately left of the **Background Shapes** layer.

This step — locking the Background Shapes layer — is simply a safeguard to avoid accidentally changing the background rectangles while you're drawing the icon artwork.

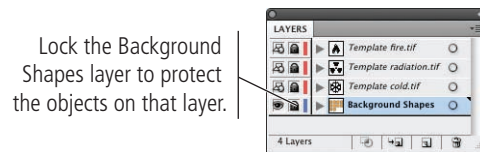

18. In the Layers panel, click the **New Layer** button at the bottom of the panel.

In the next stage of the project, you will start tracing the object in the template. The completed icon will be a black icon on top of the rounded rectangle with the gold background color.

At this point, most of the gold color in the background shapes is obscured by the placed images, because the template layers are above the layer containing the rectangles. If you tried to draw the icon shapes on the existing non-template layer, you would be drawing *behind* the template — in other words, you wouldn't be able to see what you were drawing. Instead, you need a layer above the template layers, where you can create the icon artwork.



19. In the Layers panel, drag **Layer 5** to the top of the layer stack.

New layers are automatically placed immediately above the selected layer. You need this new layer to be above the template layers so you can see what you're drawing.

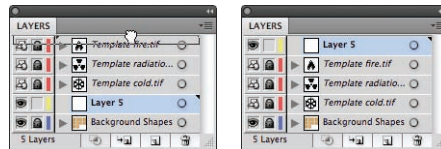

20. Double-click the **Layer 5** name in the Layers panel. Change the layer name to **Icon Art**. Choose **Dark Green** from the Color menu and click OK.

The Color option determines the color of bounding box handles and other visual indicators for objects on a layer. (The default for Layer 5, Yellow, can be very difficult to see. We chose Dark Green because it shows better in our screen shots.)

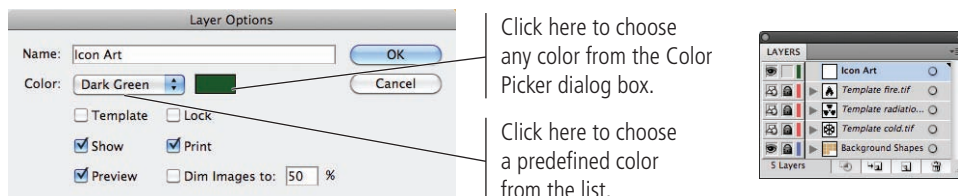

21. Save the file and continue to the next stage of the project.

Stage 2 Drawing Basic Shapes

If you remember from the client meeting, the client's bitmap icons work fine on the Web, but they look terrible in print. After you redraw the icons in Illustrator, the client will be able to print them anywhere, with no loss in quality — which is the primary advantage of vector-based artwork vs. raster-based images. A number of tools and utilities can be used to create complex Illustrator artwork. Creating the icons in this project gives you an opportunity to experiment with some of these options. As you complete the other projects in this book, you will delve deeper into complex drawing techniques.

CREATE ARTWORK WITH LINES

The snowflake icon is really nothing more than a series of straight lines — which makes it an ideal image to introduce the Illustrator Line Segment tool. In this exercise, you create simple lines, and then use some basic modification techniques to create the final icon.

1. With `icons.ai` open, make sure the Icon Art layer is selected. Zoom in to the top-left rectangle (with the snowflake image).
2. In the Tools panel, select the Line Segment tool, and then click the Default Fill and Stroke button.

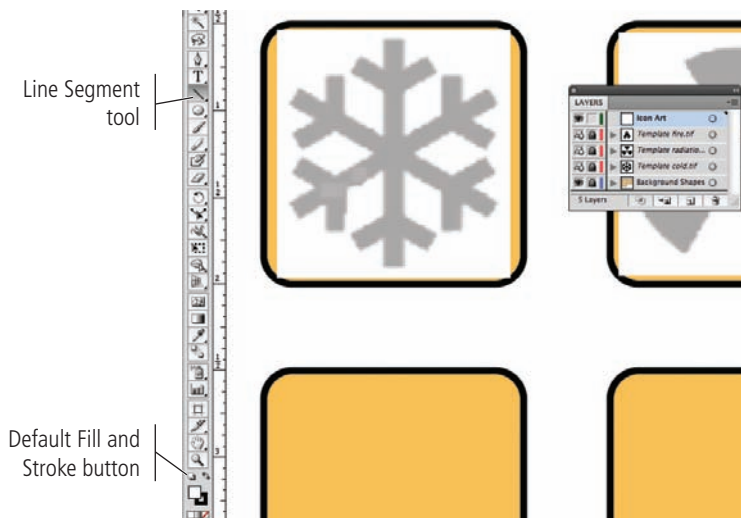

3. Click at the bottom of the vertical line in the snowflake image, and then drag up to the top of the snowflake image. Release the mouse button while the cursor feedback shows the line at 90°.

As you drag, the cursor feedback shows the length and — more importantly in this case — the angle of the line you're drawing. If you don't see the cursor feedback, choose `View>Smart Guides` to toggle on that option.

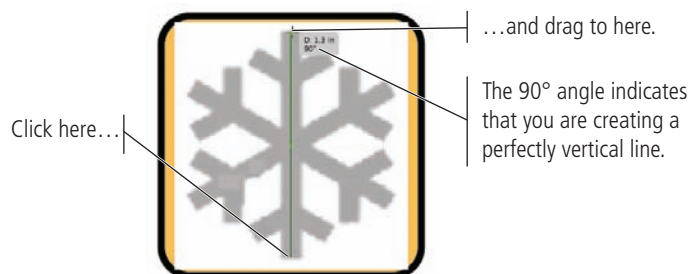

Note:

You can also press `Shift` to constrain a line to increments of 45°.

4. With the Line Segment tool still active, click the cursor on the top of the left flake branch in the template image. Hold down the mouse button, drag down and right until you see the word “path” appear near the cursor, then release the mouse button.

The word “path” is another function of Illustrator’s Smart Guides; when you drag near an existing path, Illustrator identifies the path so you can place a point exactly on top of the existing path.

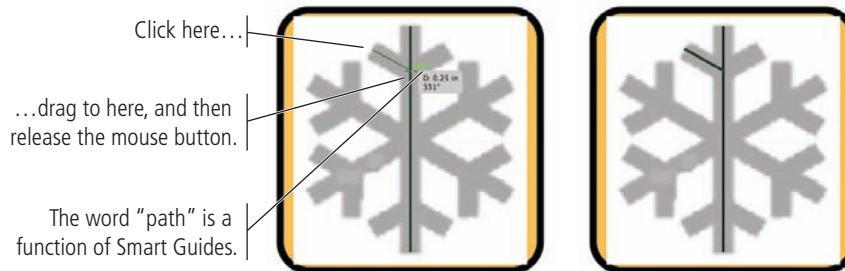

5. Move the cursor to the top of the right flake branch until you see a green line connecting to the top of the left branch that you drew in Step 4.
6. Click the mouse button, drag down and left until the word “anchor” appears next to the cursor, and then release the mouse button.

The “anchor” label indicates that you have dragged to the position of an existing anchor point (in this case, the endpoint of the left flake branch). As you can see, Illustrator makes it easy to create precise lines and shapes in relation to other objects on the page.

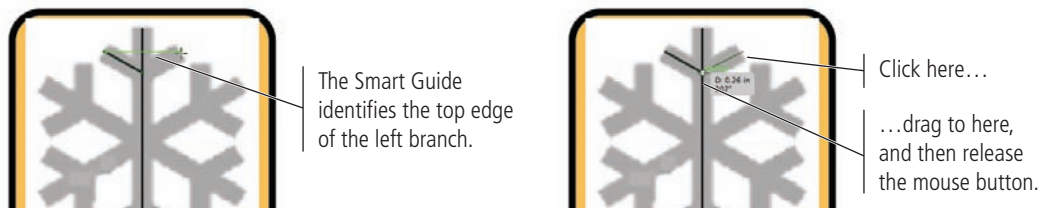

7. Choose the Selection tool from the Tools panel, and then click the vertical line you drew in Step 3. Choose Object>Lock>Selection.

When an object is locked, you can’t select or change it — just as locking a template layer protects the template object from being moved. In the next few steps, you select and join the endpoints of the two angled lines, which is much easier if the vertical line can’t be selected (you want the vertical line to remain unchanged).

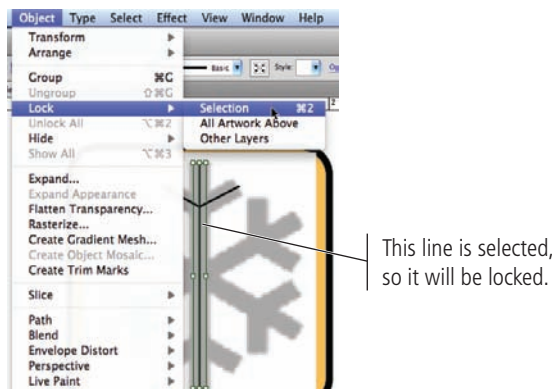

8. Using the Direct Selection tool, drag a marquee around the bottom points of both angled lines.

You want to join the lines' endpoints, so you need to select only those specific points (instead of the entire lines). As mentioned earlier, you need the Direct Selection tool to select specific points on a path.



9. Choose Object>Path>Join.

This command connects any two selected open endpoints. If the selected points overlap, as in this exercise, the two points are simply combined into a single corner endpoint. If the two selected points do not overlap, Illustrator automatically connects them with a straight line segment.

10. Choose the Selection tool to reveal the bounding box for the selected object.

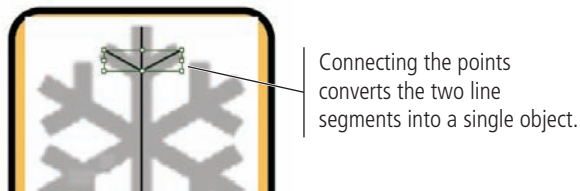

11. Save the file and continue to the next exercise.

REFLECT DRAWING OBJECTS

Illustrator includes four important transformation tools — Rotate, Reflect, Scale, and Shear. Each of these transformations can be applied by hand using the related tool in the Tools panel, as well as numerically using the appropriate dialog box from the Object>Transform menu.

Much of the work you do in Illustrator requires changing objects that already exist. In this exercise, you use reflection to create additional sections of the snowflake icon.

1. With icons.ai open, choose the Selection tool in the Tools panel. Make sure the angled-branch object is selected on the artboard.

Because the Selection tool is active, you can now see the bounding box of the selected object — both angled lines, which have been joined into a single object.

2. Choose Object>Transform>Reflect.

You can reflect objects around the vertical or horizontal axis at specific degrees. In this case, you want to make the branches at the bottom of the snowflake, so you need to reflect the object around the horizontal axis.

3. In the Reflect dialog box, make sure the Preview check box is active.

The Preview option, which is available in all of the Illustrator transformation dialog boxes, allows you to see the effects of your changes before you commit them.

4. Choose the Horizontal option and click Copy.

If you click OK in any of the transformation dialog boxes, the transformation directly affects the selected object. Because you want another branch for the bottom of the flake, you are using the Copy function instead of simply clicking OK.



5. With the Selection tool still active, click the reflected branches and drag them to the bottom of the flake and place the object appropriately. Use the template image as a guide.

Again, the Smart Guides function helps you place the object; the green line and cursor feedback show the angle at which you're moving the selected object, so you can more easily maintain the same horizontal position.

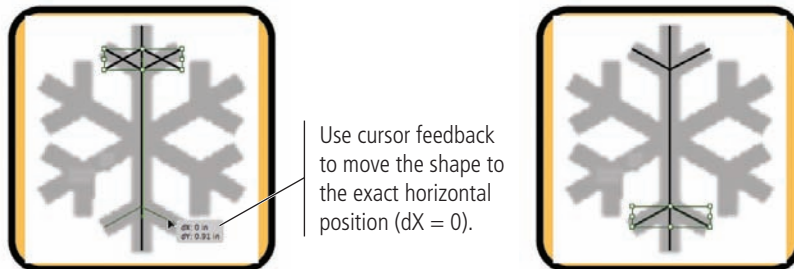

Note:

Reflecting on the horizontal axis flips the object top over bottom. Reflecting around the vertical axis flips the object left to right.

6. Choose Object>Unlock All.

Remember, you locked the original vertical line to protect it while you worked with the endpoints of the angled branches. Now that you have one complete set of branches, you can use the existing objects to create the remaining icon elements — which means you need to unlock the vertical line so you can access and copy it.

7. Choose Select>All.

All three objects — the vertical line and the two branch objects — are now selected.

8. In the Control panel, change the stroke width to 7 pt.

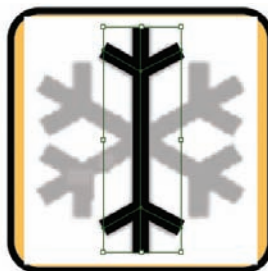

9. Choose Object>Group.

Because these three objects are basically a single entity in the icon, it's a good idea to treat them as a single object.

10. Save the file and continue to the next exercise.

ROTATE DRAWING OBJECTS

Very few projects are entirely horizontal, making rotating objects a foundational Illustrator skill. In this exercise, you use several rotation techniques to create the rest of the snowflake artwork.

1. With `icons.ai` open, make sure the grouped object is selected.
2. Activate the Rotate tool in the Tools panel.

When you select the Rotate tool, an **origin point** appears by default at the center of the selected object. This origin point is the point around which rotation occurs. If you want to rotate an object around some other point, you can single-click anywhere to define a different origin point.

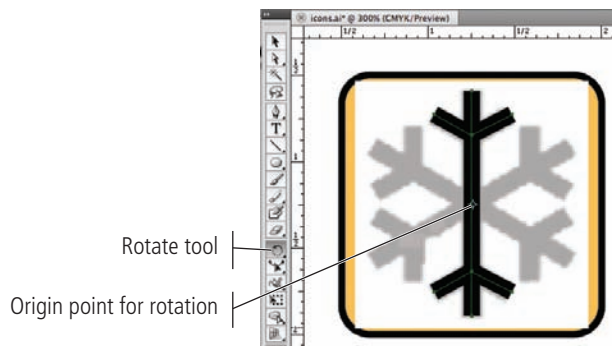

Note:

The Illustrator transformation tools all use this same origin point concept as the basis for transformations. You can click without dragging to reposition the origin point before applying the transformation.

3. Click near the top of the vertical line, hold down the mouse button, and then drag left and down until the line appears over the next branch in the snowflake. Note the angle in the cursor feedback, and then release the mouse button.

As you can see, the rotation moved the selected objects around the origin point. Unfortunately, the vertical line is no longer there because you just rotated it.

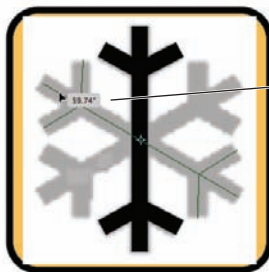

When you drag with the Rotate tool, the cursor feedback shows the angle of rotation.

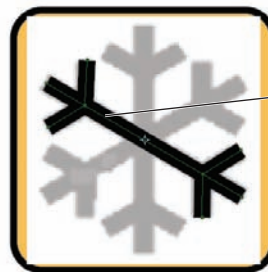

When you release the mouse button, the original object rotates.

4. Press Command/Control-Z to undo the rotation.
5. With the group still selected, double-click the Rotate tool to open the Rotate dialog box.

This dialog box is the same one you would see by choosing Object>Transform>Rotate. Transformation dialog boxes, which default to the last-used settings for that transformation, make it easy to apply very specific numeric transformations to selected objects.

- Type **60** in the Rotate field, and then click Copy.

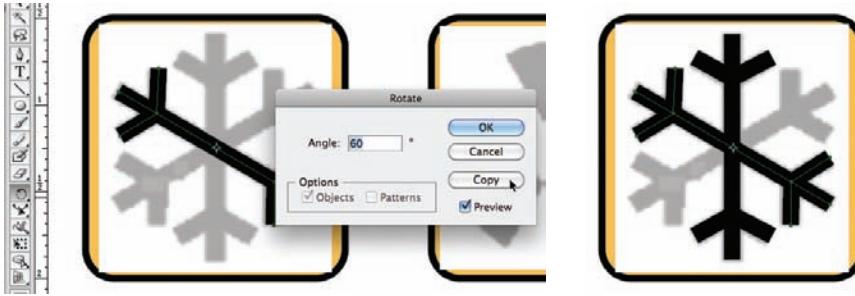

- Choose **Object>Transform>Transform Again** to create the third branch of the snowflake icon.

As before, the Transform Again command repeats the last-used transformation — in this case, the copy-rotate transformation from Step 6.



- Choose **Select>All**. Using the Control panel, click the **Vertical Align Center** and **Horizontal Align Center** buttons.

Because each “branch” is a group, the alignment functions work as you would expect. The three sets of branches are now exactly centered in both directions.

This step might not cause a noticeable change, depending on how precisely you placed the lines, but it’s a good idea to be certain that the groups align properly.

- With all snowflake objects selected, choose **Object>Lock>Selection**.
- In the Layers panel, select the **Template cold.tif** layer and click the **Delete Selection** button at the bottom of the panel. Click **Yes** in the confirmation message.

Since the snowflake drawing is complete, you no longer need the template image.

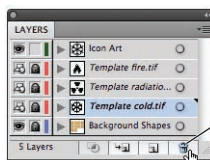

Click here to delete the selected layer.

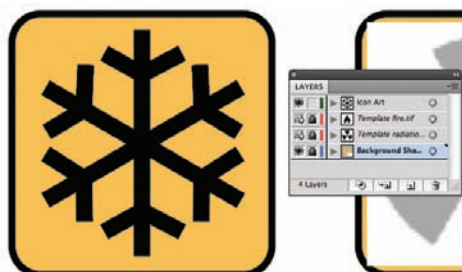
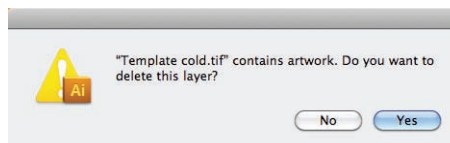

- Save the file and continue to the next exercise.

Note:

The Transform Again command applies the last-used transformation of any type to a selected object without opening a dialog box. This command might result in movement, rotation, reflection, shear, or scale, depending on the last transformation you applied.

Note:

You can Option/Alt-click and drag to clone an object while you transform it. In other words, if you press Option/Alt while dragging with the Rotate tool, you can create a rotated copy.

DIVIDE BASIC SHAPES INTO COMPONENT PIECES

Using the Illustrator Pathfinder panel, you can combine multiple shapes in a variety of ways, or you can use one object as a “cookie cutter” to remove or separate one shape from another. As you work with more complicated artwork in Illustrator, you will find many different ways to use the Pathfinder functions, either alone or in combination.

1. With **icons.ai** open, make sure the **Icon Art** layer is selected in the **Layers** panel. **Zoom into the second rectangle in the first row of background shapes.**
2. Select the **Ellipse tool** (nested under the **Rounded Rectangle tool**) in the **Tools** panel. Set the fill color to **black** and the stroke color to **None**.

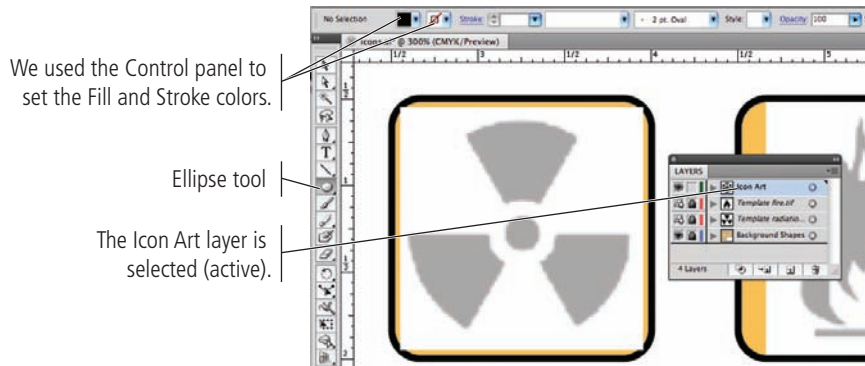

3. Click in the center of the biohazard icon, press **Option/Alt-Shift**, and then drag to create a circle that covers the entire biohazard icon.

Remember, pressing **Option/Alt** allows you to draw a shape from the center out. Pressing **Shift** constrains the shape to equal height and width.

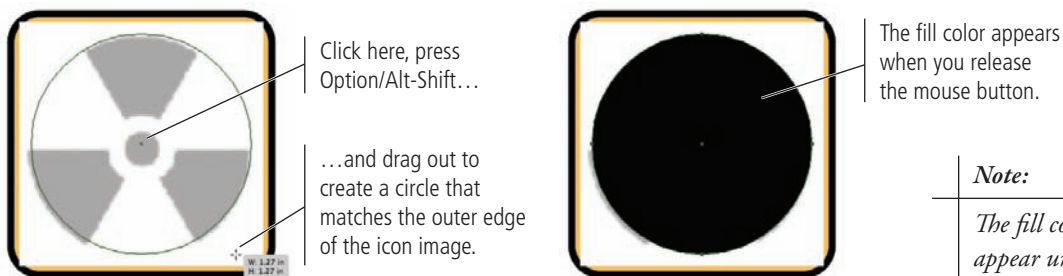

Note:

The fill color does not appear until you release the mouse button.

4. With the new circle selected, change the **Opacity** field in the **Control** panel to **50**.

Opacity defines the transparency of the selected object. In this case, you're reducing the opacity from 100% (entirely solid or opaque) so you can see the template image behind the circle you just drew.

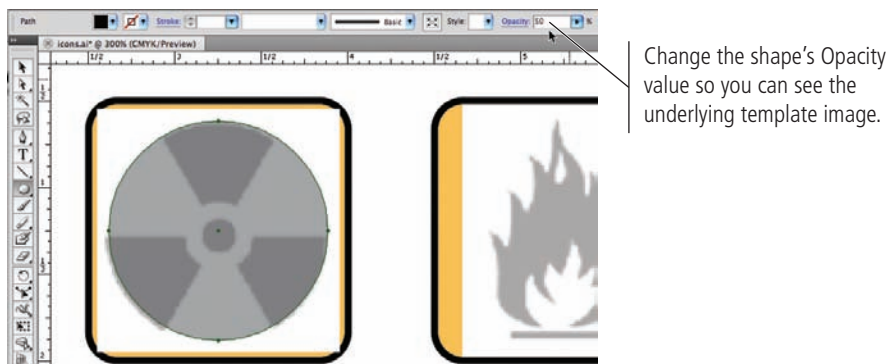

Note:

You can also use the Transparency panel to change an object's opacity.

Note:

You'll work with opacity as a design element in Project 6.

- Using the Ellipse tool, click again in the center of the template image, press Option/Alt-Shift, and drag to create the smaller circle in the center of the shape.

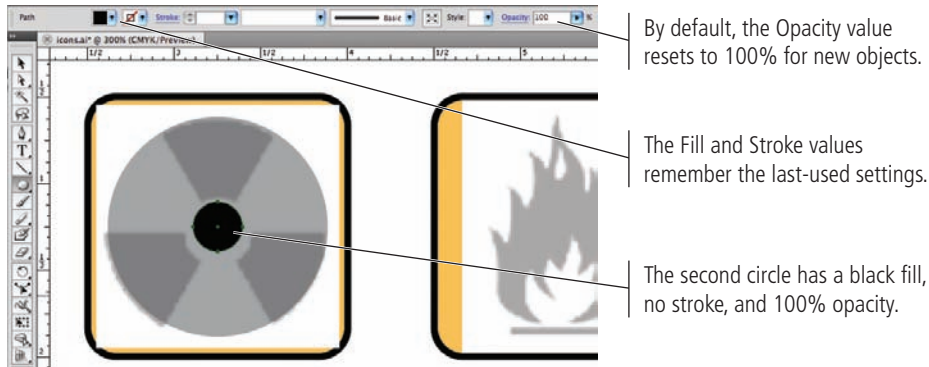

- With the smaller circle selected, change the fill color to None and the stroke color to white. Change the stroke weight to 5 pt.

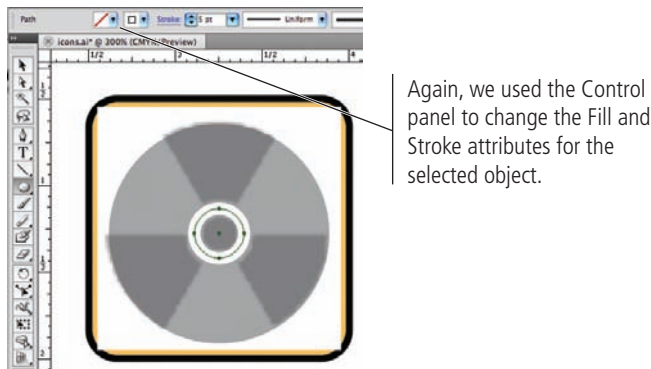

- Press Command/Control to temporarily access the Selection tool, and click away from the existing shapes to deselect them.

If you don't deselect the circle, changing the Fill and Stroke attributes in the next step will change the attributes of the selected shape.

- Choose the Line Segment tool in the Tools panel, and then click the Default Fill and Stroke button at the bottom of the Tools panel.

- Move the cursor below the circles you created until you see the Smart Guide connecting to the existing shape's center point. Click and drag up to create a vertical line that extends past the top edge of the outer circle.

Although none of the icon wedges have a vertical line, it's easier to start at vertical and rotate the objects as necessary.

Note:

To create the vertical line, use the cursor feedback to drag a 90° line, or press Shift to automatically constrain the line to 90°.

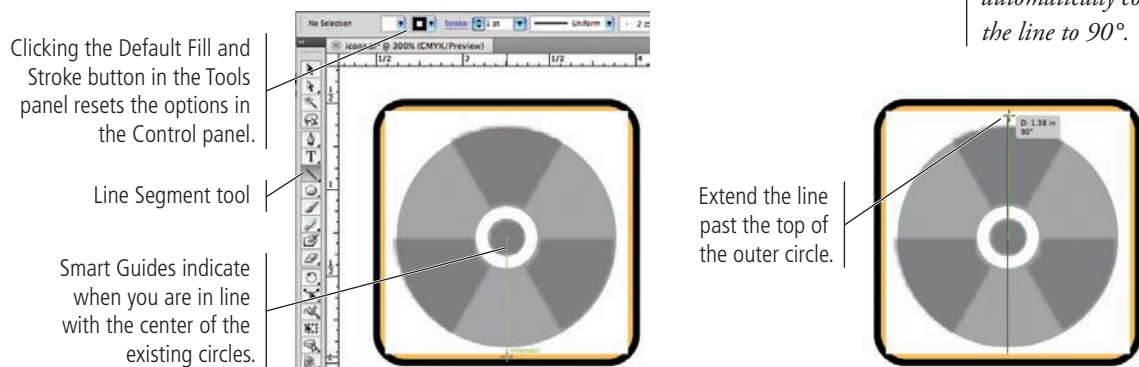

10. Using the Selection tool, draw a marquee around the three objects that you have created to select them all. Use the options in the Control panel to align the selected objects horizontally and vertically.

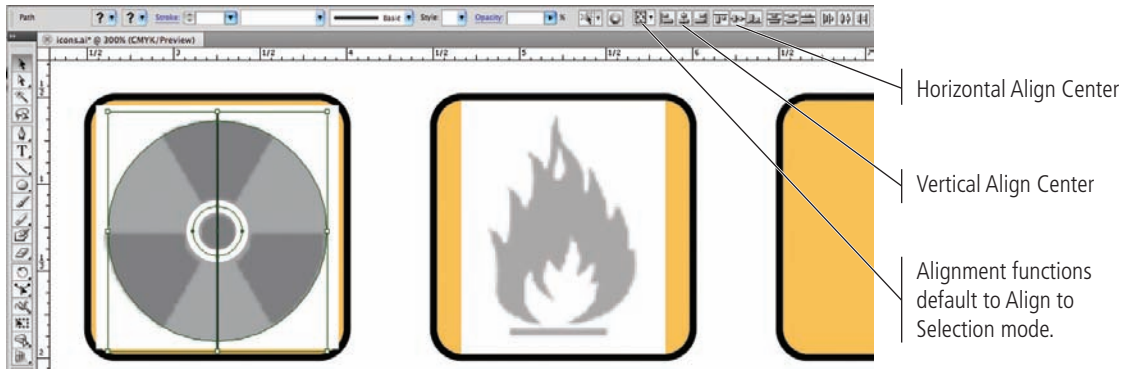

11. Click away from the selected objects, and then select only the vertical line.

The icon has six wedges, which means each half of the circle needs to be divided into three pieces. To accomplish this, you use precise rotation to slice the larger circle into the necessary parts.

12. With the vertical line selected, choose **Object>Transform>Rotate**. Type **60** in the Angle field and click **Copy**.

This menu command has the same result as double-clicking the Rotate tool, but you don't have to switch tools.

A full circle has 360 degrees. You're cutting the circle into six equal pieces; one sixth of 360° is 60°, so this is the exact angle that you need to create the correct number of pieces.

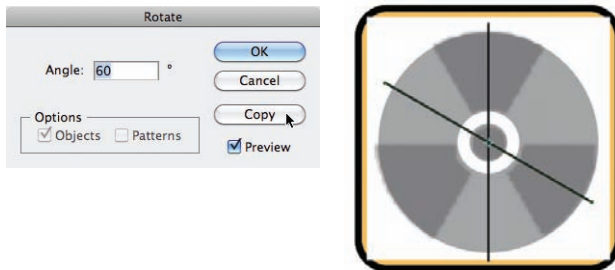

13. Choose **Object>Transform>Transform Again** to make a third line.

The Transform Again command applies the last-used transformation of any type to a selected object without opening a dialog box. Because you used the Rotate dialog box with the Copy button in the previous step, the Transform Again command copies the current selection and rotates it by the same angle you used in Step 12.

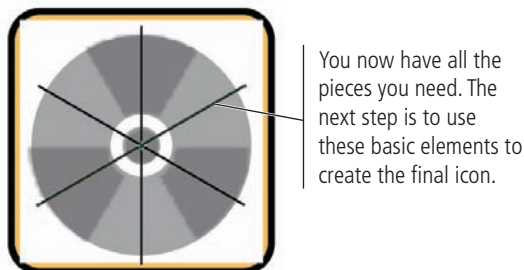

14. Using the Selection tool, select the smaller circle only and choose Object>Path>Outline Stroke.

This command changes the object stroke to a filled object. You drew the white circle to “cut out” the smaller black circle from the wedges. The Pathfinder functions recognize strokes for cutting apart shapes, but the stroke weight is not considered when the new paths are generated. To create the thick white space in the actual icon, you need to convert the heavy stroke to a filled shape.

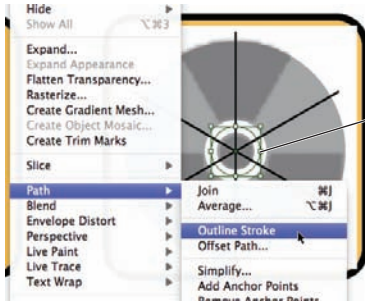

The original object had a 5-pt stroke weight.

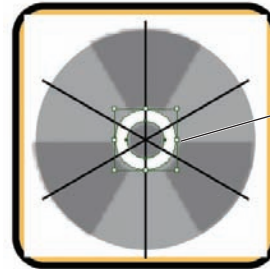

The Outline Stroke command changes the selected object to a filled shape with no visible stroke attributes.

Note:
Press Command/Control-A to select all unlocked objects on the artboard.

15. Select all the objects in the icon, and then open the Pathfinder panel (Window>Pathfinder).

You can drag a marquee with the Selection tool, or choose Select>All. Because you locked the snowflake artwork in the first icon, those objects are not selected.

The Pathfinder Panel in Depth

ILLUSTRATOR FOUNDATIONS

In the Pathfinder panel, the top row of buttons — the Shape Modes — create complex shapes by combining the originally selected shapes. (You can press Option/Alt and click a Shape Mode to maintain the paths from the original objects.)

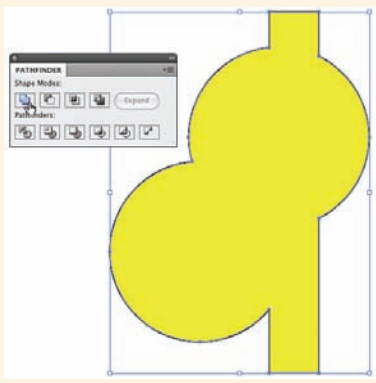

Unite combines all selected objects into a single shape.

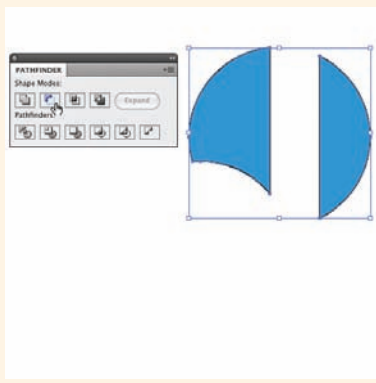

Minus Front removes overlapping areas from the backmost shape in the selection.

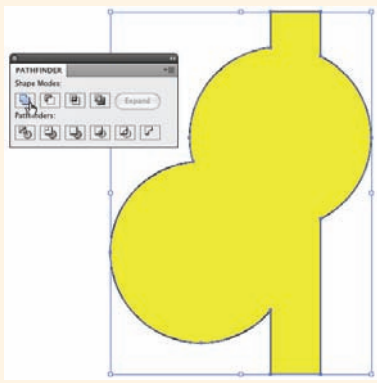

By default, the Shape options result in a single new object.

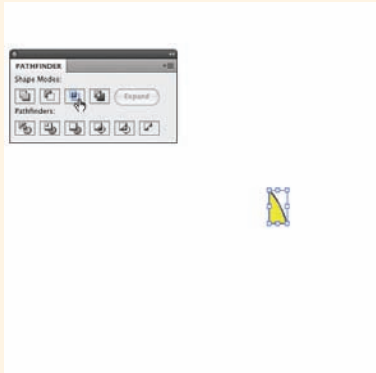

Intersect creates a shape of only areas where selected objects overlap.

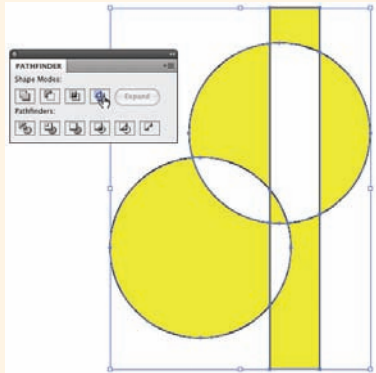

Exclude removes any areas where two objects overlap.

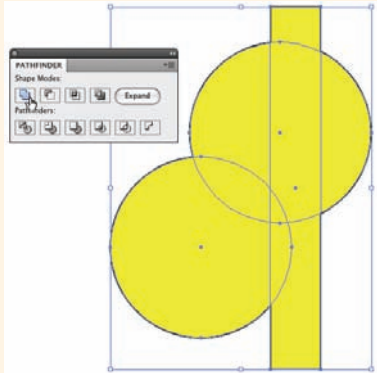

If you Option/Alt-click a shape mode button, the result maintains the original paths unless you manually expand it.

16. In the Pathfinder panel, click the Divide button.

Options in the Pathfinder panel allow you to cut shapes out of other shapes and merge multiple shapes into a single shape.

It's important to realize that many Pathfinder options can be applied in more than one way. We're using the Divide and Unite options in this exercise to give you an idea of what you can accomplish with Pathfinder.

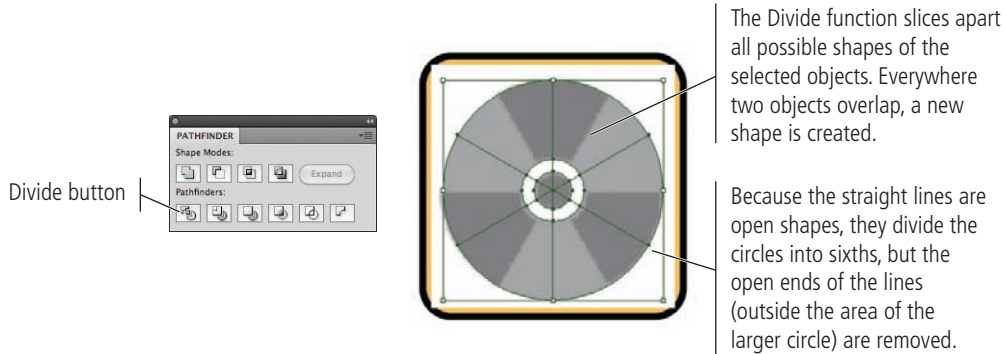

17. Save the file and continue to the next exercise.

The Pathfinder Panel in Depth (continued)

ILLUSTRATOR FOUNDATIONS

The second row of options — the Pathfinders — do exactly that. The resulting shapes are some combination of the paths that made up the originally selected objects.

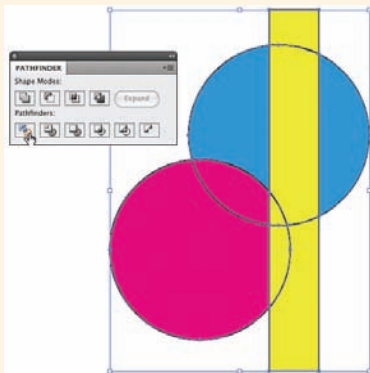

Divide creates separate shapes from all overlapping areas of selected objects.

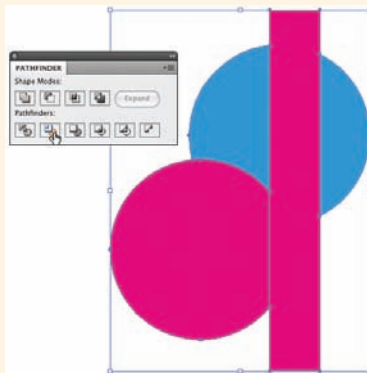

Trim removes underlying areas of overlapping objects. Objects of the same fill color are not combined.

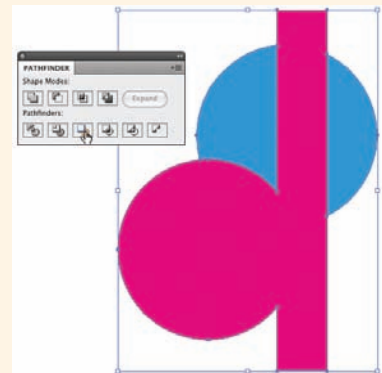

Merge removes underlying areas of overlapping objects. Objects of the same fill color are combined.

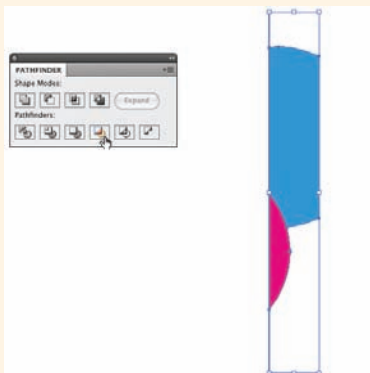

Crop returns the areas of underlying objects that are within the boundary of the topmost object.

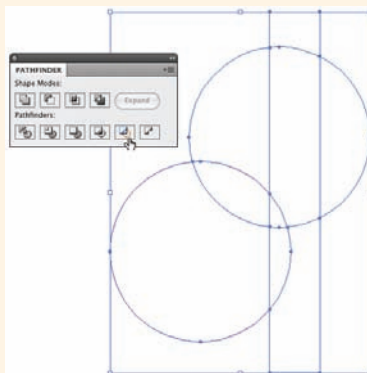

Outline divides the selected objects, then returns unfilled, open paths.

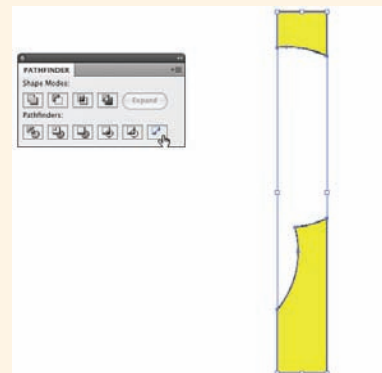

Minus Back removes the area of underlying objects from the front object.

WORK IN ISOLATION MODE

Groups can be invaluable when you need to treat multiple items as a single object. When items are grouped, it is easy to move and manipulate the entire group as a single object. In many cases, however, you will need to make changes to only part of a group. Depending on the complexity of the file, this can be very difficult without first breaking apart the group (“ungrouping”). Illustrator’s Isolation mode offers a convenient workspace, where you can work with grouped objects as if they were stand-alone objects.

- 1. With icons.ai open, use the Selection tool to double-click any of the shapes in the biohazard icon to enter Isolation mode.**

When you use the Pathfinder panel, the resulting shapes are automatically grouped. Because all of these shapes make up the icon artwork, it’s a good idea to leave them grouped. Isolation mode allows you to work with the constituent objects without ungrouping.

- 2. Using the Selection tool, click the wedge shape in the top-left area of the icon, and then press Delete.**

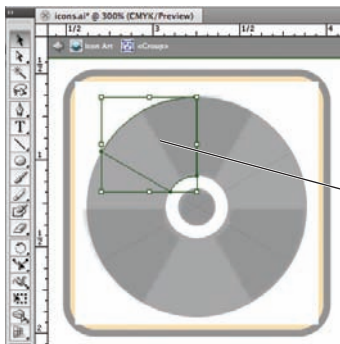

Because you’re working in Isolation mode, you can use the Selection tool to select one object, even though the object is part of a group on the main artboard.

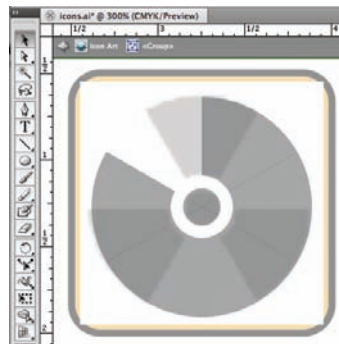

- 3. Select and delete every other wedge in the outside area of the group.**

- 4. Choose View>Outline.**

Outline mode allows you to see and work with the basic shapes only. This way, object fills don’t obscure the shapes that you need to see clearly.

- 5. Click in the center set of wedges and drag a marquee that encompasses the center points of all six center wedges.**

If you tried to do this in Preview mode, clicking one of the filled shapes and dragging would actually move the shape you clicked. Because the fills are not technically present in Outline mode, you can use the click-drag method to select all six shapes instead of Shift-clicking each one individually.

Be sure you don’t click on any actual line when you begin to draw the selection marquee. If necessary, zoom in so you can clearly see the empty spaces in the small wedge shapes.

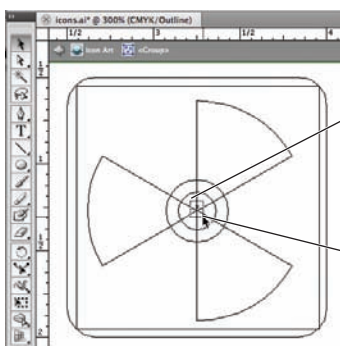

In Outline mode, you can’t see or interact with the objects’ Fill attributes.

Because you can’t select an object’s fill, you can drag a selection marquee to select only the six small shapes in the icon center.

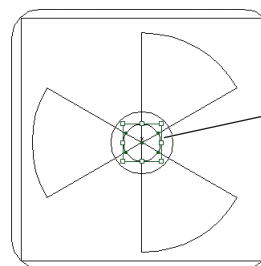

When you release the mouse button, you can see that all six objects are selected.

6. In the Pathfinder panel, click the Unite button.

This function merges the selected shapes into a single object.

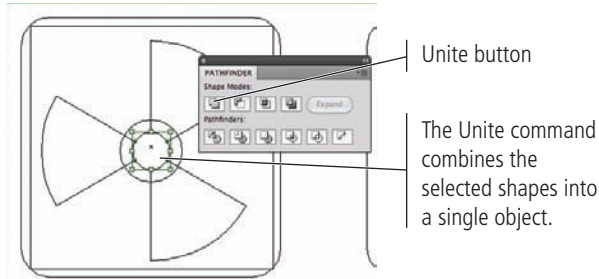

7. Choose View>Preview to exit Outline mode and display the normal artwork.

8. Using the Selection tool, click to select any one of the black (partially transparent) objects.

9. In the Control panel, click the Select Similar Objects button and choose Opacity from the menu.

The options in this menu (and in the Select>Same menu) are very useful for finding objects that share specific attributes.

Note:

The Select Similar functions can also be accessed in the Select>Same menu.

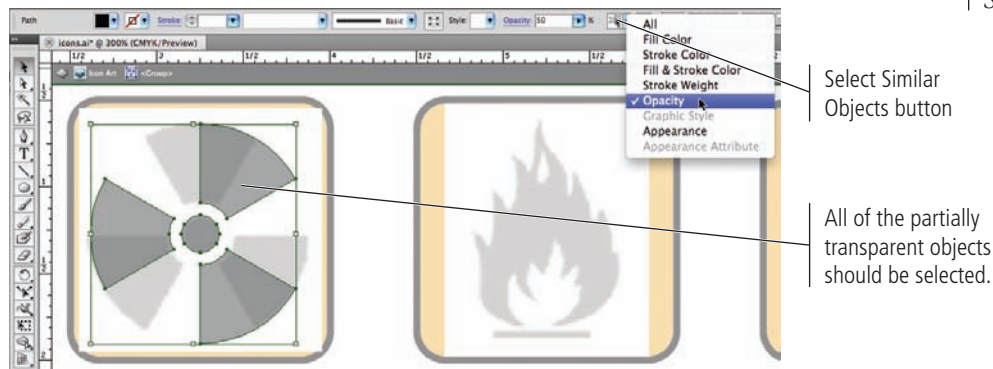

10. Change the Opacity value (in the Control panel) to 100 for the selected objects.

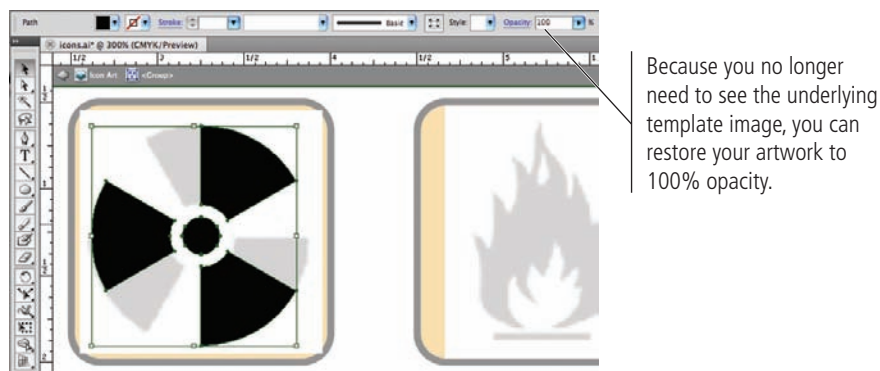

11. At the top of the document window, click the arrow button twice to return to the main artboard.

Your icon is almost complete; you only need to rotate the shape to match the image.

12. Save the file and continue to the next exercise.



USE MEASUREMENTS TO ADJUST YOUR ARTWORK

Depending on the type of work you do, Illustrator drawings can be entirely freeform, precisely measured, or a combination of the two (as in this case). You have already used a number of tools that help you create exactly what you need where you need it — Smart Guides, document rulers, the Transform panel, and even the Control panel all offer ways to precisely move and size objects on the artboard.

You can also use the Measure tool, which evaluates different dimensional attributes of objects on the page. As you might expect from the name, the Measure tool acts like a digital tape measure. In addition to sizes and positions, the tool also measures angles — an important feature for technical drawing that requires precise detail.

1. With `icons.ai` open, choose the Measure tool in the Tools panel (nested under the Eyedropper tool).
2. Click at the outside corner of the left wedge, and then drag down and right along the shape edge (as shown in the following image).

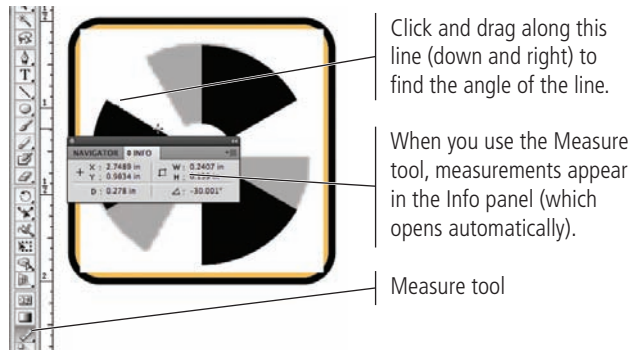

Note:

If you drag from the inside out, the Info panel shows an angle of 150°. This provides the same information, because 180° — your goal — minus 150° equals 30°.

The Measure tool tells you that the angle of this line is -30° . You need it to be 180° (horizontal), which means you need to rotate the shape by 30° .

3. Select the group with the Selection tool, and then choose **Object>Transform>Rotate**.
4. Change the Angle field to **30** and click OK.

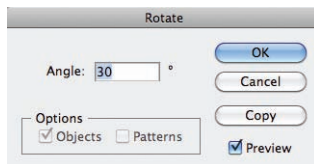

5. In the Layers panel, select and delete the Template radiation.tif layer.

After you remove the template image, you can see the remaining problem — the Divide Pathfinder function left a white ring in the shape. You need to remove these white objects.



6. Click away from all objects to deselect the icon artwork.

7. Using the Direct Selection tool, click the fill of one of the white shapes to select it.

Remember, all of the constituent shapes are part of a group — the result of the Pathfinder Divide function — so you can't use the Selection tool. The irregular position of these small shapes also makes it difficult to individually select the six objects with the Direct Selection tool.

8. In the Control panel, click the Select Similar Objects button and choose Fill Color from the menu.

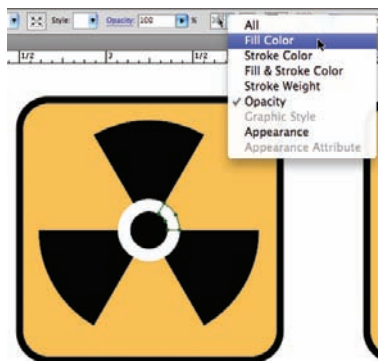

All six white-filled objects are selected because the original selection had a white fill.

9. With all six white shapes in the icon selected, press Delete.



10. Select all objects in the radiation icon art and choose Object>Lock>Selection.

This step protects the completed icon artwork from being inadvertently changed while you work on the rest of this project.

11. Save the file and continue to the next exercise.

Note:

Be careful when you use the Select Similar functions. They select all similar unlocked objects on the entire artboard. If the art for another icon had a white fill, for example, it would also be selected.

DRAW WITH THE PENCIL TOOL

At this point, you have used a number of basic shapes to create finished icon artwork. As you might already realize, however, not all artwork can be created from basic shapes and lines. Illustrator includes everything you need to create artwork in any form, from a basic square to irregular shapes without a single visible straight edge. The Pencil tool is one method for creating custom shapes. Like a regular pencil on a piece of paper, the Pencil tool creates lines that follow the path of your cursor. (If you have a digital drawing tablet, the Pencil tool can be particularly useful for drawing custom artwork.)

Note:

In Project 2, you will learn how to use the Pen tool to control every point and path of your Illustrator drawings.

1. With **icons.ai** open, make sure the **Icon Art** layer is selected in the **Layers** panel. Zoom in to the third rectangle in the first row of background shapes.
2. Choose the **Pencil tool** and click the **Default Fill and Stroke** button in the **Tools** panel.

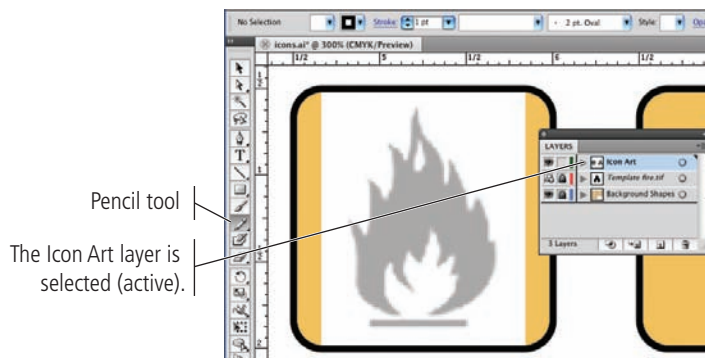

3. Double-click the Pencil tool in the Tools panel.

Double-clicking certain tools in the Tools panel opens an Options dialog box, where you can control the default behavior for the selected tool. The Pencil tool options include:

- **Fidelity.** This option determines how far apart anchor points are added as you drag. Higher values result in fewer points and smoother lines; lower values result in more anchor points, which can make the lines appear choppy.
- **Smoothness.** This option determines how closely a path follows the path of your cursor. Lower values result in more anchor points, especially if your cursor movement is choppy.
- **Fill New Pencil Strokes.** By default, pencil paths are not filled regardless of the fill color defined in the Tools panel.
- **Keep Selected.** If this option is checked, the line you draw is automatically selected when you release the mouse button.
- **Edit Selected Paths.** If this option is checked, drawing near a selected path can change the existing path. This is an important distinction (especially when Keep Selected is checked) because you can accidentally edit the first path instead of creating a second shape.

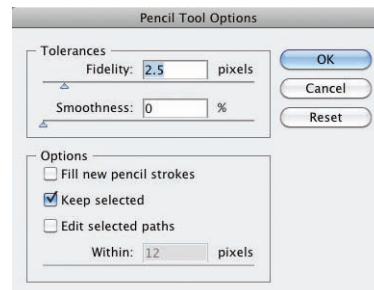

4. Set the Fidelity value to **2.5 pixels** and Smoothness to **0%**.

To draw this icon, you must make many fine movements and change direction often. Even though this icon artwork doesn't have to be exact to communicate the necessary message ("fire"), you should try to match the template as closely as possible.

5. Make sure the **Fill New Pencil Strokes** and **Edit Selected Paths** options are unchecked, and then click **OK**.

6. Click at the bottom-left point of the fire icon, hold down the mouse button, and begin dragging around the shape of the fire. When you get near your original starting point, press **Option/Alt** and release the mouse button.

As you drag, a colored line indicates the path you're drawing. Don't worry if the path isn't perfect; when you release the mouse button, Illustrator automatically smooths the path.

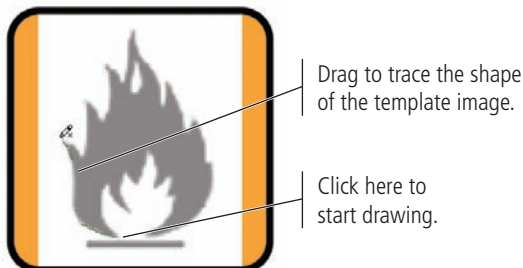

The Pencil tool creates open-ended lines. To create a closed shape with your path, press **Option/Alt** before releasing the mouse button at your original starting point.

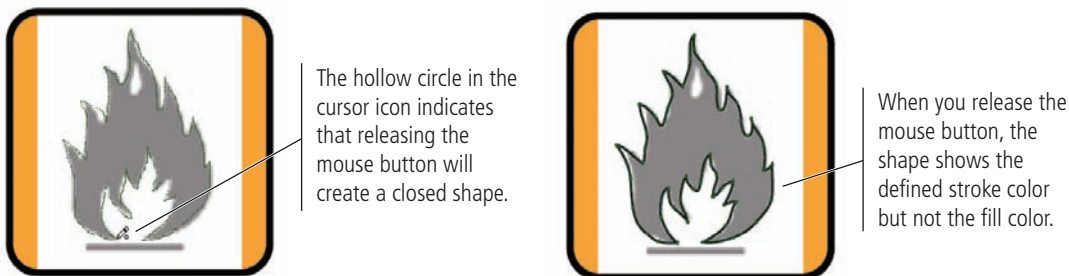

7. Click near the top point of the white flame area (inside the first path) and drag to create the white inner shape in the fire icon. Press **Option/Alt** before releasing the mouse button so you end up with a closed shape.

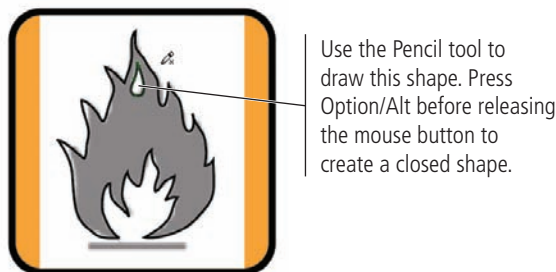

8. Using the **Rectangle tool**, draw the shape below the fire in the template image.



9. In the **Layers panel**, delete the **Template fire.tif** layer.

- Use the Selection tool to select all three shapes of the icon art. Change the fill color to black and the stroke color to None.

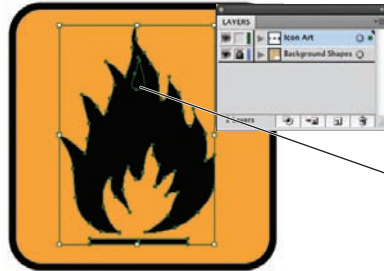

When all three objects are filled, you can't see the inner shape at the top of the flame.

Note:

*A **compound path** is a single shape made up of more than one path. Compound paths usually have inner “empty” areas, such as the letter O or Q.*

- Choose **Object>Compound Path>Make**.

This option combines all three selected shapes into a single shape; the area of the smaller shape is removed from the larger shape behind it.

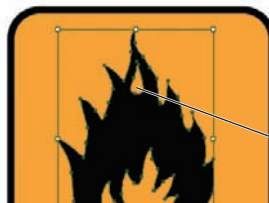

As a compound path, the inner shape is removed from the outer shape.

- Save the file and close it.

Using Live Trace to Create Artwork from Images

In many cases, the basic drawing tools are often not enough to efficiently create the artwork you need. When you need to create artwork from a placed image — as in the case of the low-resolution icons that you're using in this project — you can also use the Live Trace function to create vector graphics from placed bitmap images. (Be sure you don't place the image using the Template option.)

When an image is selected, choose **Object>Live Trace>Tracing Options** to open the Tracing Options dialog box. (A number of defined presets are also available in the Live Trace menu.)

When you use the Live Trace function, the result is a special type of object, which you can edit by changing the settings in the Live Trace dialog box. To access the individual paths and anchor points of the traced shape, you first have to expand the Live Trace object by choosing **Object>Expand**.

(Our goal in this project is to teach you the basics of drawing in Illustrator, so we don't include a complete exercise on Live Trace here. You will use it in Project 8 to create a full-color graphic from a placed photograph. However, feel free to experiment with the different options; a number of additional icon files are provided in the **WIP>Symbols** folder.)



Original placed image



Result using the built-in Black and White Logo preset



Result using the custom settings shown at right

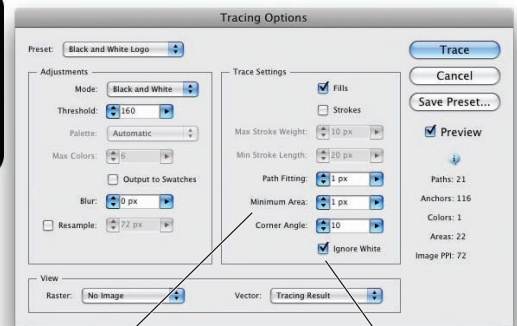

With Preview active, we adjusted the various settings to fine-tune the result.

Checking Ignore White removes the white areas of the placed image.

Project Review

fill in the blank

1. _____ are composed of mathematical descriptions of a series of lines and points; they are resolution independent, can be freely scaled, and are automatically output at the resolution of the output device.
2. _____ are pixel-based, made up of a grid of individual pixels (rasters or bits) in rows and columns.
3. The _____ is a rectangle that marks the outermost edges of an object, regardless of the actual object shape.
4. _____ is the relative top-to-bottom order of objects on the artboard, or of layers in the Layers panel.
5. The _____ is used to select entire objects or groups.
6. The _____ is used to select individual paths and points of a shape, or to select component pieces within a group.
7. The _____ is used to draw freeform paths defined by dragging the mouse cursor.
8. Press _____ to temporarily access the Selection tool; releasing the modifier key restores the previously selected tool.
9. The _____ is used to create complex shapes by combining multiple selected objects.
10. A(n) _____ is a single object that is made up of more than one shape.

short answer

1. Briefly explain the difference between vector graphics and raster images.
2. Briefly explain the difference between the Selection tool and the Direct Selection tool.
3. Briefly explain the difference between Shape Mode and Pathfinder operations in the Pathfinder panel.

Project Summary

The skills that you learned in this project will serve as the foundation for most work you create in Illustrator. You learned how to place raster images as templates, from which you created scalable vector graphics that will work in virtually any printed application. You learned a number of techniques for selecting objects and component pieces of objects, as well as various options for aligning objects relative to one another and to the artboard.

You learned how to draw primitive geometric shapes, and how to control the color of objects' fill and stroke attributes. You used a number of transformation options, including cloning methods to copy existing objects. Finally, you learned how to draw freeform shapes to suit more complex needs. As you move forward in this book, you will build on the basic skills you learned in this project to create increasingly complex artwork.

Create and transform basic rectangles with rounded corners

Control object fill and stroke color

Use various techniques to select objects, groups, and the component pieces of those objects and groups

Use a variety of methods to place objects relative to one another



Clone, rotate, and mirror basic lines



Use the Pathfinder to combine basic shapes into complex artwork



Use the Pencil tool and compound paths to draw complex shapes